



HIGH PRECISION

TOOL-A-THON[®]



over
100 NEW
Tool-A-Thon items!



Volume 21.2

Valid May 1st - Aug. 31th

www.fowlerprecision.com



NEW PRODUCTS!

Check out the scannable QR codes for product details and videos!

Quadra Check

Page 10 • Bluetooth Test Indicators



Mini S_Dial Indicators

Page 10 • Bluetooth, small sized



Hi_Cal Height Gages

Page 6-7 • NOW with Bluetooth



Roto Dial Holder

Page 44 • 360° Indicator positioning



Xtra-Height PLUS

Page 46 • Economical dimensional measuring



Xtra-MAG Height PLUS

Page 47 • Limited space height gage



Space X-BLOX PLUS Sets

Page 50 • Work set-up sets



Xtra-Tri PLUS Square Set

Page 50 • Layout and measuring squares



Weight & Counting Scale

Page 55 • 66 lb. capacity



Fowler Sylvac Ultralight IV Electronic Calipers

The Fowler Sylvac Ultralight IV, new design, new features, built-in Bluetooth transmitter. Discover our amazing Ultralight long range calipers.

**Tool-A-Thon
Special Pricing**



Features:

- IP67 protected against fluid and dust
- Built-in Bluetooth
- New reinforced frame
- XXL display with 0.79"/20mm high digits
- Increased accuracy
- Lengthened jaws 7.9"/200mm
- Includes upper ID measuring pins (5mm dia.)
- New system for internal measurement
- Moveable left jaw
- Stainless steel titanium coated jaws
- Hold feature
- Preset function
- Min/Max functions
- Tolerance mode
- Internal and external measurement indicator

**See it in
ACTION!**



Alternative jaws available, contact the Fowler Technical Department for more information 1-800-788-2353

Specifications	54-110-512-0	54-110-524-0	54-110-540-0	54-110-560-0	54-110-580-0	54-110-600-0
Measuring Range	0-15"/0-400mm	0-24"/0-600mm	0-40"/0-1000mm	0-60"/0-1500mm	0-80"/0-2000mm	0-100"/0-2500mm
Maximum Error	0.0012"/30µm	0.0016"/40µm	0.002"/50µm	0.0035"/90µm	0.0048"/120µm	0.0078"/200µm
Repeatability	0.0008" /20µm			0.0012"/30µm		
Measuring Force	5 - 10 N					
Connection	Bluetooth Smart/Proxi. - RS-232 or - USB					
Protection Rating	IP67 (Electronic Module)					
Preset Max.	±399.9995 IN / ±9999.99 mm					
Weight	3.3 lbs/1.5 kg	3.5 lbs/1.6 kg	4.1 lbs/1.9 kg	5 lbs/2.3 kg	5.7 lbs/2.6 kg	6.3 lbs/2.9 kg

Order No.	Range	List Price	Sale Price
54-110-512-0	0 - 15"/0 - 400mm	\$2,189.38	\$2,025.20
54-110-524-0	0 - 24"/0 - 600mm	\$2,607.72	\$2,412.20
54-110-540-0	0 - 40"/0 - 1000mm	\$3,003.15	\$2,778.00
54-110-560-0	0 - 60"/0 - 1500mm	\$4,515.16	\$4,176.60
54-110-580-0	0 - 80"/0 - 2000mm - <i>special order</i>	\$6,092.58	\$5,635.70
54-110-600-0	0 - 100"/0 - 2500mm - <i>special order</i>	\$7,421.54	\$6,865.00
Connectivity Cables/Accessory			
54-115-526-0	Proximity USB Cable	\$198.87	\$135.00
54-115-527-0	Proximity Serial Cable	\$202.69	\$135.00
54-115-246-BT	USB Bluetooth Receiver	\$50.80	\$45.80

Prices & Specifications are subject to change without notice.

21.2



SWISS Hand Tools



V-Series Special Pricing!

Fowler Trimos V3, V4 & V5 Electronic Height Gages

The Fowler Trimos V3, V4 and V5 vertical measuring instruments have been developed for the most difficult workshop environments. Manufactured in Switzerland, they guarantee a robust, precise and reliable product.

Features:

- "Black Mask" display with user friendly functions
- Electronically adjustable measuring force 0.75/1.5 (N)
- Lithium-ion rechargeable batteries last up to 40 hours
- All adjustments possible without tools
- Cast iron base for optimal stability and rigidity
- RS232 and USB interfaces requires 54-192-112-0 cable. Bluetooth transmitter also available
- Dual probe holders (V4 - V5)
- Carriage displacement: Manual for V3 and V4 models
V5 includes selectable manual or motorized carriage displacement
- Measures heights, diameters, perpendicularity, centerlines, Min/Max/Delta
- Resolution: 0.00005"/0.001mm
- Repeatability (2s): 0.00008"/0.002mm (Ø 0.00016"/0.004mm)

All models Include:

- Charging unit
- Measuring insert with ruby ball Ø4mm
- Probe holder elbow Ø 8mm
- Setting gage
- User's manual and test certificate

EXTREMELY Easy to Use!

***Height Gages available up to 40", 60", 80" upon request**

V3	54-192-340-0	54-192-370-0
Measuring Range	16"/407mm	28"/711mm
Range with Probe inverted	20"/508mm	31.9"/812mm
Max. Permissible Errors	0.00028"/0.007mm	0.00032"/0.008mm
Frontal Squareness Deviation	0.0004"/0.010mm	0.0006"/0.015mm
Air Cushion		NO
V4	54-191-440-0	54-191-470-0
Measuring Range	16"/407mm	28"/711mm
Range with Probe inverted	28.3"/719mm	40.2"/1023mm
Max. Permissible Errors	0.0002"/0.005mm	0.00028"/0.007mm
Frontal Squareness Deviation	0.0004"/0.010mm	0.0006"/0.015mm
Air Cushion		YES
V5	54-199-540-0	54-199-570-0
Measuring Range	16"/407mm	28"/711mm
Range with Probe inverted	28.3"/719mm	40.2"/1023mm
Max. Permissible Errors (µm)	2.5 + L(mm)/300	
Frontal Squareness Deviation	0.0002"/0.005mm	0.00032"/0.008mm
Air Cushion		YES



See it in
ACTION!



Order No.	Description	Range	List Price	Sale Price
54-192-340-0	V3 Height Gage	16"/407mm	\$4,730.41	\$4,129.65
54-192-370-0	V3 Height Gage	28"/711mm	\$5,215.46	\$4,553.10
54-191-440-0	V4 Height Gage	16"/407mm	\$6,231.03	\$5,539.69
54-191-470-0	V4 Height Gage	28"/711mm	\$7,248.66	\$6,428.08
54-199-540-0	V5 Height Gage	16"/407mm	\$6,867.42	\$6,095.26
54-199-570-0	V5 Height Gage	28"/711mm	\$8,138.14	\$7,204.60
Probe Sets				
54-199-105-0	4mm Probe Set, 21 piece		\$1,819.90	\$1,588.77
54-199-106-0	8mm Probe Set, 16 piece		\$1,358.04	\$1,200.00
54-199-107-0	8mm Basic Probe Set, 7 piece		\$482.16	\$450.00
Accessories				
54-199-400-0	12"/300mm Holder - for 8mm probes		\$1,018.76	\$889.38
54-199-022-BT	Bluetooth transmitter for (Not available for V3 models)		\$675.00	
54-777-120-0	Vmux software - for connecting multiple units to one PC		\$465.50	\$418.95

16"/407mm
\$4,129.⁶⁵

Order No: 54-192-340-0

16"/407mm
\$5,539.⁶⁹

Order No: 54-191-440-0



Measures ID/OD, centerlines,
heights, widths, depths,
min/max/delta, slots,
grooves and more!

NOW
available with ISO Cert

 Contact the Fowler Sales
Department 1-800-788-2353

28"/711mm
\$7,204.⁶⁰

Order No: 54-199-570-0

FREE Basic Probe Set

 with a V4 and V5
Tool-A-Thon 21.2 purchase
\$480.00 value!

54-199-107-0



Fowler Sylvac **BLUETOOTH** Hi_Cal Electronic Height Gages

Features:

- **Quick, easy computer recorded measurements**
- Extra low measuring force, from 0.2N
- Measure internal and external diameters, centerlines, heights, widths, depths and MIN/MAX/TIR capability
- Excellent repeatability thanks to the motorized carriage
- High reliability
- Bluetooth, USB and RS232 data outputs
- Battery life: 40 hours rechargeable during operation
- Touch sensitive probe speed for easy operation
- Base with small footprint
- Includes: protective cover, charging set, ruby ball probe Ø3mm, setting gage and calibration certificate



54-931-150-BT

FREE 1mm Ball Probe
with 6"/150mm and 12"/300mm Hi_Cal Purchase!



Accessory Probe Sets



54-930-215-0

54-930-217-0



FREE Basic Probe Set
with 54-931-450-BT Hi_Cal Purchase \$675.00 Value!

Order No.	Range	Accuracy	List Price	Sale Price
54-931-150-BT	6"/150mm	0.00013"/0.0034mm	\$5,698.25	\$5,128.43
54-931-150-BT-C	6"/150mm <i>with ISO/A2LA Certification</i>			\$5,378.43
54-931-300-BT	12"/300mm	0.00016"/0.0042mm	\$6,219.85	\$5,597.87
54-931-300-BT-C	12"/300mm <i>with ISO/A2LA Certification</i>			\$5,947.87
54-931-450-BT	17.5"/450mm	0.00020"/0.005mm	\$7,080.10	\$6,372.09
54-931-450-BT-C	17.5"/450mm <i>with ISO/A2LA Certification</i>			\$6,722.09
Accessories				
54-930-215-0	Full Probe Accessory Set		\$1,659.78	\$1,215.00
54-930-217-0	Basic Probe Accessory Set		\$940.80	\$675.00



54-931-300-BT



See it in
ACTION!



54-931-450-BT

NOW

available with ISO Cert

Contact the Fowler Sales
Department 1-800-788-2353



Fowler Ultra-Cal VI Electronic Calipers



54-100-167-0

See it in
ACTION!



Features:

- IP67 protected against fluid and dust
- Available with or without Bluetooth
- Heavy duty frame
- Extra large display
- NOW available with ISO Cert
- 12"/300mm is supplied without depth rod

LIFETIME
WARRANTY



Calibration certificates available for all sizes

Order No.	Range	Accuracy	Resolution	List Price	Sale Price
Without Data Output					
54-100-177-0	6"/150mm	0.0008"/20µm	0.0005"/0.01mm	\$172.73	\$164.09
54-100-178-0	8"/200mm	0.0012"/30µm	0.0005"/0.01mm	\$354.55	\$336.82
54-100-179-0	12"/300mm	0.0012"/30µm	0.0005"/0.01mm	\$468.11	\$444.70
Bluetooth Models					
54-100-167-0	6"/150mm	0.0008"/20µm	0.0005"/0.01mm	\$398.37	\$378.45
54-100-168-0	8"/200mm	0.0012"/30µm	0.0005"/0.01mm	\$645.90	\$613.61
54-100-169-0	12"/300mm	0.0012"/30µm	0.0005"/0.01mm	\$860.60	\$817.57
Accessory					
54-115-246-BT	USB bluetooth receiver			\$50.80	\$45.80

Fowler Ultra-Cal VI Proximity Electronic Calipers



54-100-444-1

Features:

- IP67 protected against fluid and dust
- Ultra-Cal VI technology with proximity cable data output
- Heavy duty frame
- Extra large display
- 12"/300mm is supplied without depth rod

LIFETIME
WARRANTY



Order No.	Range	Accuracy	Resolution	List Price	Sale Price
54-100-444-1	6"/150mm	0.0008"/20µm	0.0005"/0.01mm	\$188.99	\$179.54
54-100-448-1	8"/200mm	0.0012"/30µm	0.0005"/0.01mm	\$390.91	\$371.36
54-100-412-1	12"/300mm	0.0012"/30µm	0.0005"/0.01mm	\$527.27	\$500.91
Connectivity Cables					
54-115-526-0	Proximity cable with USB connection			\$198.87	\$135.00
54-115-527-0	Proximity cable with serial connection			\$202.69	\$135.00

Fowler Rapid-Mic Quick-Displacement Electronic Micrometers

21.2



SWISS Hand Tools



**WORLD'S FINEST
Micrometer!**



"I have been in the machining business for over 30 years this is by far the best mic I have ever had. One little thing or should I rephrase that, one huge thing, this mic comes with a lifetime warranty...no other company can provide that!"
John T.

Features:

- Fastest micrometer on the market
- IP67 protected against fluid and dust
- Position recall
- Adjustable measuring force, 5N/10N (54-815-030-0 and 54-815-130-0 only)
- Menu customizable with free software
- Non-rotating spindle with 10mm travel per thimble rotation
- USB output or Bluetooth available

LIFETIME WARRANTY

See it in ACTION!



54-815-111-0

Calibration certificates available for all sizes

Order No.	Range	Accuracy	List Price	Sale Price
54-815-030-0	0 - 1.18"/0 - 30mm	0.00012"/0.003mm	Compare to Mitutoyo 293-676-20 @ \$560.00 \$513.95	
54-815-060-0	1.18" - 2.6"/30 - 66mm	0.00016"/0.004mm	\$990.15	\$959.15
54-815-100-0	2.6" - 4.0"/66 - 102mm	0.00020"/0.005mm	\$1,224.37	\$1,159.81
Set				
54-815-111-0	0 - 4"/0 - 102mm		\$2,820.47	\$2,679.45
Bluetooth Models				
54-815-130-0	0 - 1.18"/0 - 30mm	0.00012"/0.003mm	\$924.22	\$792.40
54-815-160-0	1.18" - 2.6"/30 - 66mm	0.00016"/0.004mm	\$1,214.24	\$1,090.80
54-815-110-0	2.6" - 4.0"/66 - 102mm	0.00020"/0.005mm	\$1,438.52	\$1,366.59
Bluetooth Set				
54-815-112-0	0 - 4"/0 - 102mm		\$3,526.07	\$3,299.00
Connectivity Cables/Accessory				
54-115-526-0	Proximity cable with USB connection		\$198.87	\$135.00
54-115-527-0	Proximity cable with serial connection		\$202.69	\$135.00
54-115-246-BT	USB Bluetooth receiver		\$50.80	\$45.80

Prices & Specifications are subject to change without notice.



Fowler **QuadraTest**™

Multimode Electronic Test Indicators

The Fowler QuadraTest is the perfect solution for test indicating applications

Features:

- Bluetooth connectivity to your phone or tablet
- IP65 protected against fluid and dust
- 4 measuring modes: Min, Max, TIR and Direct
- 4 measuring resolutions - 0.00005"/0.001mm or 0.0005"/0.01mm
- 1-1/2" diameter dial face rotates a full 360°
- Analog scale for reversal point indication
- Meets or exceeds DIN/ISO Standards
(Maximum error on .00005" scale at full range: 0.0004")
- **54-562-890-BT is capable of interchanging contact point lengths**

54-562-777-BT



SWISS MADE



IOT READY



Order No.	Range	Contact Point Length	List Price	Sale Price
54-562-777-BT	0.030"/0.80mm	1/2"	\$576.14	\$509.66
54-562-888-BT	0.080"/2.0mm	1-7/16"	\$651.62	\$576.43
54-562-890-BT	0.030"/0.80mm	1/2"	\$709.50	\$627.63
	0.080"/2.0mm	1-7/16"		
Accessory				
54-115-528-0	Output Cable USB		\$319.85	\$303.86

Fowler Mini S_Dial Indicators

Small in size **BIG** in features!

Features:

- All indicators features 0.50"/12.5mm range
- Bluetooth connectivity to your phone or tablet
- IP67 protected against fluid and dust
- Analog scale for reversal point indication
- 3/8" mounting diameter with 4-48 contact thread
- Auto power off feature
- Optional cable connectivity output

SWISS MADE



IOT READY

See it in ACTION!



54-520-687-BT



54-520-692-0

Order No.	Accuracy	Resolution	List Price	Sale Price
Bluetooth Models				
54-520-687-BT	0.0004"/0.01mm	0.0005"/0.01mm	\$586.20	\$518.56
54-520-690-BT	0.0002"/0.005mm	0.00005"/0.001mm	\$764.85	\$676.59
Basic Models				
54-520-691-0	0.0004"/0.01mm	0.0005"/0.01mm	\$442.81	\$391.71
54-520-692-0	0.0002"/0.005mm	0.00005"/0.001mm	\$611.36	\$540.82
Accessory				
54-115-528-0	Output Cable USB		\$319.85	\$303.86

MAKING MEASUREMENT EASY

Fowler's commitment is
NOW EVEN STRONGER! Accurate data logging for only an additional \$25.⁰⁰.

Make Your Life Easier!
Upgrade to *BLUETOOTH* today!

Fowler Mark VI Electronic Indicators

Features:

- IP54 protected against fluid and dust
- Repeatability: 2µm
- Output: Proximity/Power - USB/RS232/digimatic/Wireless
- Menus customizable with free software
- Wide range of functions (MIN/MAX/DELTA, TOL, Factor, Preset. Auto Off, etc)
- Bezel rotates 270°
- Large display with LED tolerance indicators
- Includes lug back



LIFETIME WARRANTY



See it in
ACTION!



SWISS Hand Tools

Fowler

21.2

Calibration certificates available for all sizes

Order No.	Range	Accuracy	Resolution	List Price	Sale Price
Low Resolution					
54-530-125-0	0 - 0.500"/12.5mm	0.0004"/0.01mm	0.0005"/0.01mm	\$498.16	\$440.68
54-530-145-0	0 - 1"/25mm	0.0004"/0.01mm	0.0005"/0.01mm	\$568.60	\$502.99
High Resolution					
54-530-135-0	0 - 0.500"/12.5mm	0.00012"/0.003mm	0.00005"/0.001mm	\$616.39	\$545.27
54-530-155-0	0 - 1"/25mm	0.00016"/0.004mm	0.00005"/0.001mm	\$674.27	\$596.47
54-530-175-0	0 - 2"/50mm	0.00019"/0.005mm	0.00005"/0.001mm	\$1,182.49	\$1,046.05
BLUETOOTH - Tool-A-Thon 21.2 SPECIAL PRICING					
54-530-335-0	0 - 0.500"/12.5mm	0.00012"/0.003mm	0.00005"/0.001mm	\$779.94	\$570.27
54-530-355-0	0 - 1"/25mm	0.00016"/0.004mm	0.00005"/0.001mm	\$832.77	\$621.47
NANO with Bluetooth					
54-530-635-0	0 - 0.500"/12.5mm	0.00007"/0.0018mm	0.00001"/0.0001mm	\$1,133.68	\$1,002.87
54-530-640-0	0 - 1"/25mm	0.00008"/0.0022mm	0.00001"/0.0001mm	\$1,235.50	\$1,092.94
Analog Display					
54-530-535-0	0 - 0.500"/12.5mm	0.00012"/0.003mm	0.00005"/0.001mm	\$671.55	\$521.20
54-530-555-0	0 - 1"/25mm	0.00016"/0.004mm	0.00005"/0.001mm	\$734.23	\$569.80
Accessory					
54-115-246-BT	USB Bluetooth Receiver			\$50.80	\$45.80



Fowler Wyler Clinotronic-S

The Clinotronic-S is a portable precision instrument for measuring inclinations up to $\pm 45^\circ$.

The large, backlit, high contrast color display provides excellent readability even under adverse conditions in the workshop or under a machine.



Order No. 54-635-605-0

Sale \$3,467.¹⁰

List \$3,649.48

Features:

- Wireless functionality (APP wylerUNIVERSAL for Android™)
- Data transmission via USB cable as well
- User friendly
- Adjustable to local gravity
- Improved mechanical accuracy
- Excellent color display with low power consumption

Fowler Wyler Clinotronic Plus

The Fowler Wyler Clinotronic Plus is an electronic level with unsurpassed versatility. It is economically priced, uses a specially designed microprocessor and the well-proven Wyler inclination sensor.



Order No. 54-635-601-0

Sale \$2,070.¹⁰

List \$2,179.05

Features:

- Range of $\pm 45^\circ$, capacity of 0-360°
- Resolution of 0.01° (selectable)
- Absolute or relative measuring mode selectable by push button
- Seal-tec technology for excellent performance even in difficult environmental conditions
- Interface connection RS-232 is integrated. Special purpose cables available
- No loss of calibration data by power failure
- Response time: value available within 5 seconds
- Repeatability: $< 0.1^\circ$
- Linearity: 3 min. of arc + 1
- Housing: aluminum hard anodized.
- Dimensions: 4 x 3 x 1" (100 x 75 x 30mm)

SCAN For More Info



GIROD-TAST Indicators

The ultimate in Swiss workmanship, Fowler GIROD-TAST Indicators are internationally respected as "The Best."

Features:

- Monobloc body design has 7 fine jeweled bearings
- Rugged anti-magnetic one-piece housing
- Auto-reverse mechanism
- Carbide contact points
- Dovetails supplied at top, front and back for proper set-up
- Adjustable bezel and dial easily set and reset to zero
- Total measuring range 0.060" (52-562-252-0, 52-562-452-0 only)
- The convenient revolution counter indicates the total number of revolutions for error-free readings (52-562-252-0, 52-562-452-0 only)
- Price includes indicator, fitted case, carbide contact points (see chart), and two dovetail clamping stems: 7/32" and 1/4" diameter



52-562-252-0



52-562-453-0

52-562-272-0 shown



Order No.	Dial Reading	Dial Grad.	Total Range	Dial Dia.	Accuracy	Dia. Points	
						Included	Point Length
52-562-253-0	0-4-0	0.0001"	0.008"	1"	0.00016"	0.040", 0.080" & 0.120"	0.500"
52-562-453-0	0-4-0	0.0001"	0.008"	1-1/2"	0.00016"	0.040", 0.080" & 0.120"	0.500"
52-562-252-0	0-15-0	0.0005"	0.060"	1"	0.00065"	0.040", 0.080" & 0.120"	0.800"
52-562-452-0	0-15-0	0.0005"	0.060"	1-1/2"	0.00065"	0.040", 0.080" & 0.120"	0.800"
52-562-474-0	0-10-0	0.0005"	0.020"	1-1/2"	0.00065"	0.040", 0.080" & 0.120"	1.5"
52-563-453-0	0-100-0	0.002mm	0.2mm	38mm	0.0035mm	1, 2 & 3 mm	12.5mm
52-563-253-0	0-100-0	0.002mm	0.2mm	28mm	0.0035mm	1, 2 & 3 mm	12.5mm

Order No.	Description	List Price	Sale Price
Inch			
52-562-253-0	Horizontal GIROD-TAST Indicator	\$237.53	\$225.70
52-562-453-0	Horizontal GIROD-TAST Indicator	\$260.52	\$247.50
52-562-252-0	Horizontal GIROD-TAST Indicator	\$305.35	\$290.10
52-562-452-0	Horizontal GIROD-TAST Indicator	\$285.20	\$271.00
52-562-474-0	Vertical GIROD-TAST Indicator	\$344.03	\$326.90
Metric			
52-563-453-0	Horizontal GIROD-TAST Indicator	\$269.48	\$199.00
52-563-253-0	Horizontal GIROD-TAST Indicator	\$270.62	\$257.10



Outside Inch Micrometers



52-240-001-1



52-215-003-1

Features:

- Microfine graduations on satin chrome finish and carbide tipped measuring faces
- Diameter of measuring faces: 0.256"
- Graduation: 0.0001"
- Flatness: 0.00003"
- Positive lever locking clamp
- Spindle thread hardened, ground and lapped for ultimate accuracy
- Anvil & spindle hardened and precision ground with microlap finish on tips
- Includes a wrench and case
- Sizes over 1"/25mm include a calibration standard

Order No.	Range	Accuracy	Thimble	List Price	Sale Price
52-240-101-1	0 - 1"	± 0.00016"	Ratchet	\$47.19	\$42.47
52-240-002-1	1" - 2"	± 0.00016"	Friction	\$54.89	\$49.40
52-240-102-1	1" - 2"	± 0.00016"	Ratchet	\$54.89	\$49.40
52-240-003-1	2" - 3"	± 0.0002"	Ratchet	\$64.13	\$57.72
52-240-004-1	3" - 4"	± 0.0002"	Ratchet	\$71.61	\$64.45
52-240-005-1	4" - 5"	± 0.00024"	Ratchet	\$79.31	\$71.38
52-240-006-1	5" - 6"	± 0.00024"	Ratchet	\$86.90	\$78.21
52-240-007-1	6" - 7"	± 0.00028"	Ratchet	\$94.49	\$85.04
52-240-008-1	7" - 8"	± 0.00028"	Ratchet	\$111.21	\$100.09
52-240-009-1	8" - 9"	± 0.00032"	Ratchet	\$126.39	\$113.75
52-240-010-1	9" - 10"	± 0.00032"	Ratchet	\$143.33	\$129.00
52-240-011-1	10" - 11"	± 0.00036"	Ratchet	\$158.51	\$142.66
52-240-012-1	11" - 12"	± 0.00036"	Ratchet	\$173.69	\$156.32
Sets					
52-215-003-1	0 - 3" with standards and fitted shop hardened case			\$164.45	\$148.01
52-215-012-1	0 - 12" with standards and fitted wooden case			\$1,212.53	\$1,091.28
52-215-612-1	6 - 12" with standards and fitted wooden case			\$799.92	\$719.93

Interchangeable Anvil Micrometers

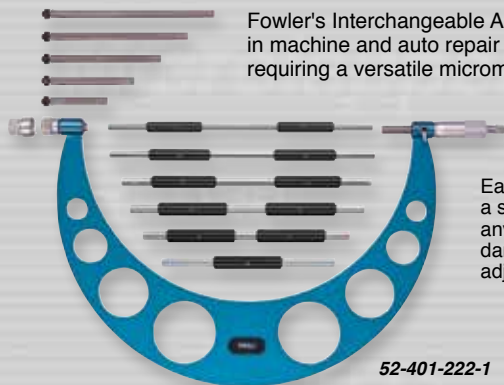

Fowler's Interchangeable Anvil Micrometers are very popular in machine and auto repair and for all other applications requiring a versatile micrometer.

Each micrometer is equipped with a series of easily interchangeable anvils to fulfill the ranges listed. Standards are also included to accurately adjust the required range.

52-401-222-1

Features:

- Parallelism: 0.0004"
- Flatness: 0.00003"
- Graduations are microfine on satin chrome for easy reading
- Each anvil is fitted with an adjusting collar to set the overall dimension
- Spindle thread is hardened and precision ground with microlap finish in carbide tipped measuring faces
- Ratchet stop ensures exact readings
- A wrench is included for fast, easy zero adjustment on the sleeve
- Positive lever locking clamp assures accurate settings
- Standards are included with each set

Order No.	Range	Graduation	Accuracy	List Price	Sale Price
52-401-221-1	0 - 6"	0.0001"	0.00024"	\$297.91	\$275.60
52-401-222-1	6" - 12"	0.0001"	0.00024"	\$437.51	\$404.70
52-401-204-1	12" - 16"	0.001"	0.00036"	\$525.05	\$498.80
52-401-205-1	16" - 20"	0.001"	0.00036"	\$612.48	\$581.90

Outside Inch Micrometers

with Decimal Equivalents on Frame



52-235-001-1



Features:

- Black decimal equivalents on satin chrome finished forged steel frame
- Graduations: 0.0001"
- Ratchet thimble and locking nut
- Sizes over 1"/25mm include a calibration standard

Order No.	Range	Accuracy	Thimble	List Price	Sale Price
52-235-001-1	0 - 1"	± 0.00016"	Ratchet	Compare to Starrett T230RL @ \$204.30	\$67.62
52-235-002-2	1" - 2"	± 0.00016"	Ratchet	\$86.90	\$78.21
52-235-003-2	2" - 3"	± 0.0002"	Ratchet	\$108.68	\$97.81
Set					
52-235-100-0	0 - 3"			\$237.40	\$213.66

Prices & Specifications are subject to change without notice.

Outside Inch Micrometers



52-253-001-1

**Tool-A-Thon
Special Pricing**

Features:

- Carbide tipped measuring faces
- Graduation: 0.001"
- Diameter of measuring faces: 0.256"
- Positive locking lever
- Anvil & spindle hardened and precision ground with microlap finish on tips
- Sizes over 1"/25mm include a calibration standard

Order No.	Range	Accuracy	Thimble	List Price	Sale Price
52-253-001-1	0 - 1"	± 0.001"	Friction	<i>Compare to Brown & Sharpe 599-1-44 @ \$115.00</i>	\$28.00
52-253-002-1	1" - 2"	± 0.001"	Friction	\$47.19	\$33.00
52-253-102-1	1" - 2"	± 0.001"	Ratchet	\$47.19	\$33.00
52-253-003-1	2" - 3"	± 0.001"	Ratchet	\$54.89	\$38.00
52-253-004-1	3" - 4"	± 0.001"	Ratchet	\$64.13	\$43.00
52-253-005-1	4" - 5"	± 0.001"	Ratchet	\$71.61	\$48.00
52-253-006-1	5" - 6"	± 0.001"	Ratchet	\$79.31	\$55.00

Outside Inch Micrometer Set

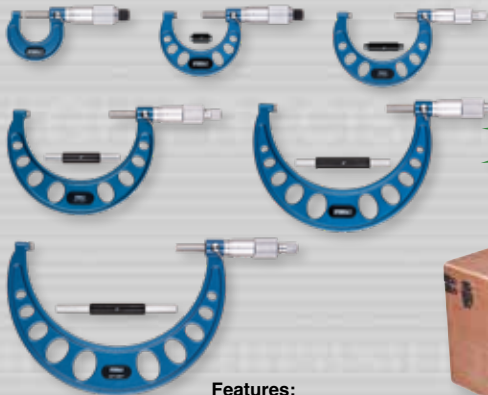

**Tool-A-Thon
Special Pricing**

Features:

- Range: 0 - 6"
- Carbide tipped measuring faces
- Graduation: 0.001"
- Diameter of measuring faces: 0.256"
- Positive locking lever
- Anvil & spindle hardened and precision ground with microlap finish on tips
- Sizes over 1"/25mm include a calibration standard

Order No. 52-253-600-1

Sale \$297.⁹⁰

List \$364.10

Digit Counter Micrometers



52-224-001-1

★★★★★
"Perfect"
J.J

Features:

- Digital counter reads to 0.001"
- Resolution: 0.0001" (using vernier)
- Microfine graduations on satin chrome
- Carbide tipped measuring faces
- Positive locking nut on spindle
- Sizes over 1"/25mm include a calibration standard
- Includes case

Order No.	Range	Accuracy	List Price	Sale Price
52-224-001-1	0 - 1"	0.00016"	<i>Compare to Mitutoyo 193-211 @ \$160.00</i>	\$105.50
52-224-002-1	1" - 2"	0.00016"	\$135.41	\$98.50
52-224-003-1	2" - 3"	0.0002"	\$154.22	\$112.20
52-224-004-1	3" - 4"	0.0002"	\$169.73	\$123.50
52-224-005-1	4" - 5"	0.00024"	\$179.63	\$135.00
52-224-006-1	5" - 6"	0.00024"	\$187.77	\$141.00
Sets				
52-224-103-1	0 - 3" set		\$406.89	\$296.00
52-224-104-1	0 - 4" set		\$577.06	\$419.70
52-224-220-1	0 - 75mm set		\$428.45	\$311.60

Swiss-Style Micrometers



52-229-201-0

★★★★★
"Awesome set of mics!"
Erik

Features:

- 0.0001" reading
- Carbide measuring faces
- Insulated frame
- Ratchet thimble and locking lever
- Microfine graduations
- Sizes over 1"/25mm include a calibration standard
- Includes case



52-229-213-0

Order No.	Range	Accuracy	List Price	Sale Price
52-229-201-0	0 - 1"	± 0.00016"	\$61.05	\$49.00
52-229-202-0	1" - 2"	± 0.00016"	\$71.50	\$57.00
52-229-203-0	2" - 3"	± 0.0002"	\$90.95	\$72.00
52-229-204-0	3" - 4"	± 0.0002"	\$101.20	\$80.00
52-229-205-0	4" - 5"	± 0.00024"	\$125.07	\$98.00
52-229-206-0	5" - 6"	± 0.00024"	\$146.85	\$115.00
Sets				
52-229-213-0	0 - 3"	0 - 1", 1 - 2": ± 0.00016" 2 - 3": ± 0.0002"	\$220.11	\$170.00
52-229-214-0	0 - 4"	0 - 1", 1 - 2": ± 0.00016" 2 - 3", 3 - 4": ± 0.0002"	\$311.63	\$235.00

XTRA-VALUE II Electronic Micrometers



54-870-001-0

Absolute Reading!



Features:

- IP40 protected against fluid and dust
- Resolution: 0.00005"/0.001mm
- Carbide measuring faces
- Absolute and incremental modes
- Ratchet thimble
- Sizes over 1"/25mm include a calibration standard

Order No.	Range	Accuracy	List Price	Sale Price
54-870-001-0	0 - 1"/0 - 25mm	$\pm 0.00016"/0.004\text{mm}$	\$110.20	\$80.20
54-870-002-0	1" - 2"/25 - 50mm	$\pm 0.00016"/0.004\text{mm}$	\$119.02	\$86.60
54-870-003-0	2" - 3"/50 - 75mm	$\pm 0.0002"/0.005\text{mm}$	\$134.86	\$98.10
54-870-004-0	3" - 4"/75 - 100mm	$\pm 0.0002"/0.005\text{mm}$	\$150.81	\$109.70
Set				
54-870-103-0	0 - 3"/0 - 75mm		\$355.90	\$236.20

Electronic Coolant Resistant Micrometer Sets



54-860-103-1

Tool-A-Thon Special Set Price



Features:

- IP54 protected against fluid and dust
- Automatic switch off
- Resolution: 0.00005"/0.001mm
- Carbide measuring faces
- Absolute & incremental modes
- Sizes over 1"/25mm include a calibration standard

Absolute Reading!

Order No.	Range	List Price	Sale Price
54-860-103-1	0 - 3"/0 - 75mm	\$459.36	\$334.10
54-860-106-1	0 - 6"/0 - 150mm	\$1,205.92	\$1,145.62

Point Spindle & Blade Anvil Micrometer



60° pointed spindle with blade anvil for grooves and hard to reach dimensions



Features:

- IP54 protected against fluid and dust
- Range: 0 - 0.08"/0 - 20mm
- Accuracy: 0.00016"/0.004mm
- Resolution: 0.00005"/0.001mm
- Hardened steel measuring faces
- Absolute & incremental modes

Order No. 54-860-671-0

Sale \$167.⁸⁰

List \$176.57

Electronic IP54 Ball Anvil Micrometer



Ball anvil and flat spindle for measuring tubes or the insides of holes to outer edges



Features:

- IP54 protected against fluid and dust
- Range: 0 - 1"/0 - 25mm
- Accuracy: 0.00016"/0.004mm
- Resolution: 0.00005"/0.001mm
- Hardened steel measuring faces
- Absolute & incremental modes

Order No. 54-860-113-1

Sale \$105.⁰⁰

List \$141.57

Point Anvil & Spindle Micrometer

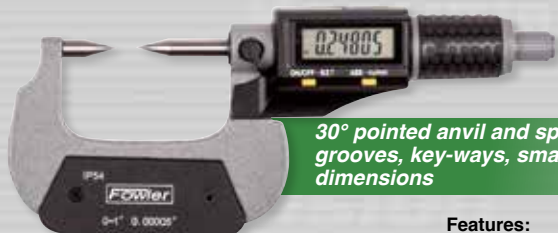

30° pointed anvil and spindle for measuring small grooves, key-ways, small flutes and hard to reach dimensions



Features:

- IP54 protected against fluid and dust
- Range: 0 - 1"/0 - 25mm
- Accuracy: 0.00016"/0.004mm
- Resolution: 0.00005"/0.001mm
- Hardened steel measuring faces
- Absolute & incremental modes

Order No. 54-860-661-0

Sale \$150.⁰⁰

List \$205.26

Vernier Thread Micrometers



52-219-001-1

Features:

- 60° measuring anvils
- Painted enamel and heat insulated frame
- Positive spindle lock
- Graduation: 0.001"
- Ratchet thimble
- Sizes over 1" include standard

Order No.	Range	Thread Range	Accuracy	List Price	Sale Price
52-219-001-1	0 - 1"	64 - 5 TPI/0.4 - 5mm	0.00016"	<i>Compare to Mitutoyo 126-137 @ \$412.94</i>	\$104.69
52-219-002-1	1" - 2"	44 - 3.5 TPI/0.6 - 7mm	0.00016"	\$130.97	\$115.25
52-219-003-1	2" - 3"	24 - 3.5 TPI/1 - 7mm	0.0002"	\$152.73	\$134.40
52-219-004-1	3" - 4"	24 - 3.5 TPI/1 - 7mm	0.0002"	\$165.39	\$145.54

Electronic IP65 Thread Micrometers



54-219-001-0

Features:

- IP65 protected against fluid and dust
- True inch/metric conversion
- 60° measuring anvils
- ABS/INC measuring mode
- Positive spindle lock
- Painted enamel and heat insulated frame
- Resolution: 0.00005"/0.001mm
- Friction thimble
- Sizes over 1" include standard



Order No.	Range	Thread Range	Accuracy	List Price	Sale Price
54-219-001-0	0 - 1"	64 - 5 TPI/0.4 - 5mm	± 0.00008"/0.002mm	\$297.88	\$262.13
54-219-002-0	1" - 2"	44 - 3.5 TPI/0.6 - 7mm	± 0.00008"/0.002mm	\$313.35	\$275.75
54-219-003-0	2" - 3"	24 - 3.5 TPI/1 - 7mm	± 0.00008"/0.002mm	\$318.20	\$280.02
54-219-004-0	3" - 4"	24 - 3.5 TPI/1 - 7mm	± 0.00012"/0.003mm	\$331.82	\$292.00

Thread Measuring Wire Set

Features:

- **NOW includes wire holders**
- 48 wires in 16 different, 3 wire sets
- Accuracy for sizes 0.018" through 0.108" is within +0/-0.0004"
- Accuracy for sizes 0.120" through 0.185" is within +0/-0.0005"
- Measures all U.S. 60° threads from 3 - 48 threads per inch



Order No. 52-485-048-0

Sale \$31.00

List \$34.98

Use blade micrometers to measure the outside diameter of workpieces which have narrow grooves, "T" slots and other dimensions.

Vernier Inch Blade Micrometers



52-246-001-1

Features:

- Anvil & spindle hardened & precision ground with microlap finish on ends
- Non-rotating spindle
- Ratchet thimble
- Blade thickness = 0.030"; blade width = 0.256"; blade penetration = 0.315"
- Sizes over 1" include a standard

Order No.	Range	Graduation	Accuracy	List Price	Sale Price
52-246-001-1	0 - 1"	0.0001"	0.00016"	\$250.51	\$231.80
52-246-002-1	1" - 2"	0.0001"	0.00016"	\$272.73	\$252.30
52-246-003-1	2" - 3"	0.0001"	0.0002"	\$284.75	\$263.40
52-246-004-1	3" - 4"	0.0001"	0.0002"	\$290.20	\$268.50

Electronic IP54 Blade Micrometers



54-860-241-0

Features:

- IP54 protected against fluid and dust
- True inch/metric conversion
- Accuracy: 0.00016"
- Resolution: 0.00005"/0.001mm
- Friction thimble
- Sizes over 1" include standard



Order No.	Range	List Price	Sale Price
54-860-241-0	0 - 1" Blade Anvil	\$309.13	\$286.00
54-860-242-0	1" - 2" Blade Anvil with standard	\$335.78	\$310.60
54-860-243-0	2" - 3" Blade Anvil with standard	\$350.75	\$324.50
54-860-244-0	3" - 4" Blade Anvil with standard	\$367.08	\$339.60

Electronic Indicating Micrometers

A superior tool in quality and design, the Fowler Bowers electronic indicating micrometer operates quickly and easily.



54-245-777-0



While supplies last!

Features:

- Retractable anvil travel: 0.275"/7mm
- Switchable resolution 0.0005"/0.01mm, 0.00005" /0.001mm
- Repeatability: 0.00005"/1μm
- Measuring force 4.5 - 6N
- Adjustable table for parts
- Two reference memories
- Preset Recall function
- Tolerance indication
- Min/Max/TIR function



Shown with 54-245-800-0 stand
sold separately

Order No.	Description	List Price	Sale Price
54-245-777-0	0 - 1.25"/0-30mm	\$1,283.20	\$1,110.00
54-245-780-0	1.25" - 2.50"/30-60mm	\$1,553.61	\$1,350.00

INDI-X[®] Indicating Micrometers



52-245-501-0

Features:

- Anvil and spindle hardened and precision ground
- Fully insulated frame, satin chrome finish
- Carbide tipped anvil & spindle
- Retracting button conveniently located in relation to operator's hand
- 0 - 1" range, thimble graduated in 0.001"
- Flatness: 0.000012"
- Dial graduated in 0.00005"
- Diameter of spindle: 0.256"
- 1" - 2" includes standard
- Includes case

Order No.	Range	Accuracy	List Price	Sale Price
52-245-501-0	0 - 1"	0.00016"	\$408.36	\$377.80
52-245-502-0	1" - 2"	0.00016"	\$473.57	\$438.10

The disc type anvil and spindle simplifies measuring the thickness of difficult, closely spaced sections, ribs, keys, fins, cutting edges on forming tools, chordal thickness of gear teeth, etc.

Electronic IP54 Disc Micrometers



54-860-301-0



Features:

- IP54 protected against fluid and dust
- Inch/metric conversion
- Resolution: 0.00005"/0.001mm
- Friction thimble for repeatability
- Extra large 0.788" disc with 0.035" edge thickness
- Easily enters hard-to-reach areas

Order No.	Range	Accuracy	List Price	Sale Price
54-860-301-0	0 - 1"/0 - 25mm	0.00016"	\$304.60	\$283.80
54-860-302-0	1 - 2"/25 - 50mm	0.00016"	\$327.85	\$303.30

Digit Counter Disc Micrometers



52-250-301-1

Features:

- Graduation: 0.0001"
- Disc diameter: 0.708"
- Disc edge thickness: 0.035"
- Ratchet thimble for repeatability

Order No.	Range	Accuracy	List Price	Sale Price
52-250-301-1	0 - 1"	0.00016"	\$183.60	\$169.90
52-250-302-1	1" - 2"	0.00016"	\$201.97	\$186.90

Disc Micrometers



52-250-111-1

Features:

- Anvil and spindle are hardened and precision ground with microlap finish on measuring faces
- Positive lever locking clamp
- Ratchet thimble for repeatability
- Graduations: 0.0001"

Order No.	Range	Accuracy	List Price	Sale Price
52-250-111-1	0 - 1"	0.00016"	\$122.59	\$113.40
52-250-112-1	1" - 2"	0.00016"	\$138.24	\$127.90

For measuring the internal diameters of tubes, bearings, slots, and more!

Electronic IP54 Inside Micrometers



Features:

- IP54 protected against fluid and dust
- Each gage includes appropriate setting ring for exceptional accuracy
- Resolution: 0.00005"/0.001mm
- Large easy-to-read LCD display
- Friction thimble
- Includes fitted case

Includes setting ring!



Order No.	Range	Accuracy	List Price	Sale Price
54-860-275-0	0.2 - 1.2"	0.00020"/0.005mm	\$273.58	\$170.00
54-860-276-0	1 - 2"	0.00024"/0.006mm	\$295.46	\$185.00

Inside Micrometers



52-275-001-1



52-275-005-0

Features:

- Measuring faces are fully hardened and precision ground
- Microlapped finished to assure exceptionally accurate readings
- Spindle threads are hardened and ground
- Microfine graduations 0.001" on a satin chrome finish permit easy reading
- Ratchet stop thimble assures exact and repetitive readings
- Includes a setting ring and fitted case

Order No.	Range	Graduation	Accuracy	List Price	Sale Price
52-275-001-1	0.2" - 1.2"	0.001"	0.0002"	\$128.92	\$108.00
52-275-005-0	0.2" - 2.2"	0.001"	0.0002"	\$225.41	\$180.00

Micrometer Stands



52-247-005-0

Features:

- Unique locking nut adjusts micrometer stand to any position for perfect use and viewing
- Stand folds for storage

XTRA MAG™

Features:

- Holds standard 0-12" micrometers firmly to metal surfaces
- Use at machine centers, work, assembly and inspection stations, steel tables and shelves
- V-bottom for mounting on cylindrical surfaces
- On/Off magnet switch
- Base is 2.30" L x 1.20" W x 3.50" H



52-247-010-0



Micrometer not included

Order No.	Description	List Price	Sale Price
52-247-005-0	Folding Micrometer Stand	\$44.99	\$32.80
52-247-010-0	Magnetic Micrometer Stand	\$79.59	\$63.00

Micrometer Inspection Set

Fowler's setting master is quick, easy to use and extremely accurate. It comes with a certificate of calibration and a fitted aluminum case. Save time and money by calibrating your own measuring tools quickly and easily.

Set Includes:

- Stand height: 12.5"
- 9 pc. Grade AS-0 gage block set (sizes: 0.625", 0.100", 0.125", 0.200", 0.250", 0.300", 0.500", 1.000" & 2.000")
- Certificate of calibration is traceable to NIST standards & provides the individual deviation of each block
- Optical flat (flatness: .000004"; Parallelism: 0.00002")
- 4.0mm ball end T-handle hex wrench



Use blocks you already have, get the holder alone!

Order No.	Description	List Price	Sale Price
53-813-001-2	Complete Checking Set	\$386.65	\$330.00
53-813-002-0	Mic Checker <i>without blocks</i>	\$193.82	\$165.00

Premium Depth Micrometers

Features:

- Clear microfine graduations on satin chrome finish
- Base constructed of hardened tool steel is precision ground and microlapped to 0.00008". All other surfaces are satin chrome finished.
- Quick and easy zero adjustment
- Rods hardened, ground and lapped on measuring surfaces and adjustable in either direction
- Interchangeable rods are fitted to the micrometer spindle against a positive stop and locked
- Ratchet thimble
- Threads hardened, ground and lapped for accuracy
- Includes spanner wrench and fitted case



52-225-005-1

Order No.	Range	Graduation	Accuracy	Base Size	List Price	Sale Price
52-225-005-1	0 - 3"	0.001"	0.0002"	2.5"	\$182.82	\$146.26
52-225-006-1	0 - 4"	0.001"	0.0002"	2.5"	\$219.34	\$175.47
52-225-011-1	0 - 4"	0.001"	0.0002"	4"	\$223.36	\$175.47
52-225-015-1	0 - 6"	0.001"	0.0002"	4"	\$249.92	\$199.94
52-225-020-1	0 - 6"	0.001"	0.0002"	2.5"	\$240.79	\$192.63
52-225-035-1	0 - 12"	0.001"	0.00028"	4"	\$389.95	\$311.96

Depth Micrometers

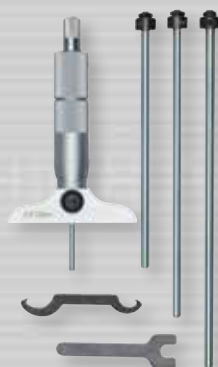

52-225-110-0

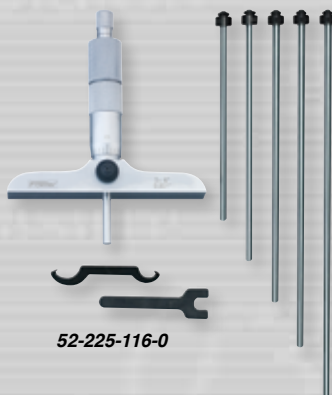

52-225-116-0

Features:

- Satin chrome finish
- Base surface hardened and microlapped to 0.00008"
- Ratchet thimble
- Locking clamp
- Rod diameter: 0.176"
- Includes fitted case

Order No.	Range	Graduation	Accuracy	Base Size	List Price	Sale Price
52-225-110-0	0 - 4"	0.001"	0.0002"	2.5"	\$153.23	\$135.00
52-225-112-0	0 - 6"	0.001"	0.0002"	2.5"	\$180.95	\$160.00
52-225-114-0	0 - 4"	0.001"	0.0002"	4"	\$165.55	\$140.00
52-225-116-0	0 - 6"	0.001"	0.0002"	4"	\$193.71	\$165.00

IP54 Electronic Depth Micrometer



Features:

- IP54 protected against fluid and dust
- Range: 0 - 6"/150 mm
- Resolution: 0.00005"/0.001mm
- Base surface hardened and microlapped to 0.00008"
- Rod diameter: 0.176"
- Automatic switch off
- Large LCD display
- Includes fitted case



Order No. 54-225-456-0

Sale \$210.00

List \$257.40

Digit Counter Depth Micrometers

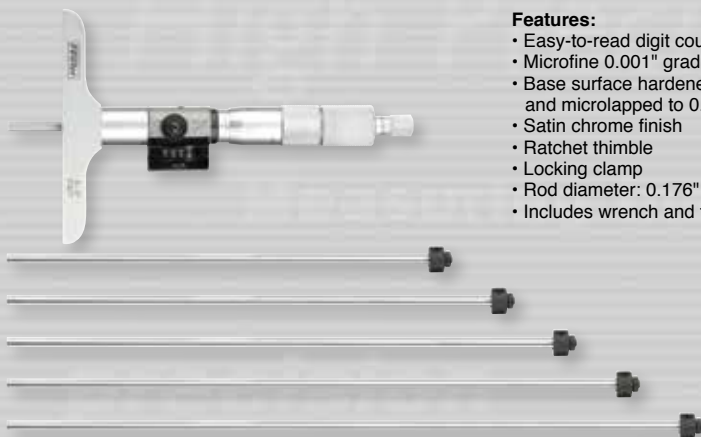

Features:

- Easy-to-read digit counter
- Microfine 0.001" graduations
- Base surface hardened and microlapped to 0.00008"
- Satin chrome finish
- Ratchet thimble
- Locking clamp
- Rod diameter: 0.176"
- Includes wrench and fitted case

52-225-226-0

Order No.	Range	Graduation	Base	List Price	Sale Price
52-225-176-0	0 - 6"	0.001"	2.5"	\$225.24	\$199.00
52-225-226-0	0 - 6"	0.001"	4"	\$250.24	\$208.00

Fowler Bowers **BLUETOOTH**

Fastest, most consistent hole measurement available world wide!



Pistol grip design significantly decreases measuring time

Measure cylinder bores, high accuracy bearings, grooves, threads and much more!



Traditional style ratchet stop thimble

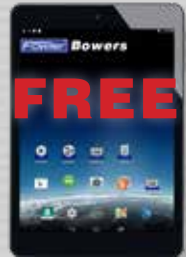

TABLET!

with Complete Set Purchase!



Both styles feature:

- IP67 protected against fluid and dust
- Resolution: 0.00005"/0.001mm
- Bluetooth connectivity to your phone or tablet
- Self centering 3 point heads above 0.250"
- Tungsten carbide measuring faces on all 3-point heads from 0.5"/12.5mm and up
- Sizes over 0.500"/12.5mm feature blind bore capability
- Includes UKAS certificates for all pistol grip, heads and rings

See it in ACTION!



Bore Gaging Systems

Special application heads operate with either style handle

Contact the Fowler Technical Department 1-800-788-2353

21.2



Bore Gaging



**2 and 3 Point
Screw Threads**



Ball Screw Threads



**2 and 3 Point
Grooves**



**Brake Caliper
Measurement**



**Ball Race
Measurement**



**Internal and External
Spline**



2 Point Spherical



3 Point Spherical



Slot Width

Order No.	Range	Includes	List Price	Sale Price
Pistol Grip Sets				
54-567-009-BT	0.080" - 0.250"/2 - 6mm (2-point heads)	5 heads, 1 handle, 3 rings	\$6,322.70	\$5,374.30
54-567-010-BT	0.250" - 0.375"/6- 10mm	2 heads, 1 handle, 1 ring	\$2,479.20	\$2,107.40
54-567-020-BT	0.375" - 0.750"/10 - 20mm	3 heads, 1 handle, 2 rings	\$2,900.40	\$2,465.40
54-567-050-BT	0.750" - 2" /20 - 50mm	3 heads, 1 handle, 2 rings	\$3,745.00	\$3,183.30
54-567-100-BT	2" - 4"/50 - 100mm	3 heads, 1 handle, 2 rings	\$4,168.40	\$3,543.20
54-567-105-BT	4" - 6"/100 - 150mm	2 heads, 1 handle, 1 ring	\$3,745.00	\$3,183.30
54-567-110-BT	6" - 8" /150 - 200mm	2 heads, 1 handle, 1 ring	\$4,943.30	\$4,201.90
54-567-200-BT	4" - 8" /100 - 200mm	4 heads, 1 handle, 2 rings	\$7,824.30	\$6,650.70
54-567-210-BT	0.750" - 4"/20 - 100mm	6 heads, 1 handle, 4 rings	\$6,094.40	\$5,180.30
54-567-620-BT	0.250" - 0.750"/6 - 20mm	5 heads, 1 handle, 3 rings	\$3,456.70	\$2,938.20
Holemike Sets (Traditional style)				
54-367-000-BT	0.080" - 0.250"/2 - 6mm (2-point heads)	5 heads, 1 handle, 3 rings	\$5,762.20	\$4,897.90
54-367-010-BT	0.250" - 0.375"/6- 10mm	2 heads, 1 handle, 1 ring	\$2,400.90	\$2,040.80
54-367-020-BT	0.375" - 0.750"/10 - 20mm	3 heads, 1 handle, 2 rings	\$2,865.00	\$2,435.30
54-367-050-BT	0.750" - 2" /20 - 50mm	3 heads, 1 handle, 2 rings	\$3,890.80	\$3,307.20
54-367-100-BT	2" - 4"/50 - 100mm	3 heads, 1 handle, 2 rings	\$4,307.70	\$3,661.60
54-367-105-BT	4" - 6"/100 - 150mm	2 heads, 1 handle, 1 ring	\$3,636.70	\$3,091.20
54-367-110-BT	6" - 8" /150 - 200mm	2 heads, 1 handle, 1 ring	\$4,803.90	\$4,083.40
54-367-200-BT	4" - 8" /100 - 200mm	4 heads, 1 handle, 2 rings	\$7,590.70	\$6,452.10
Connectivity Cables/Accessory				
54-115-526-0	Proximity cable with USB connection		\$198.87	\$135.00
54-115-527-0	Proximity cable with serial connection		\$202.69	\$135.00
54-115-246-BT	USB bluetooth receiver		\$50.80	\$45.80

Prices & Specifications are subject to change without notice.

Fowler Bowers XT-Series Holemikes

The Fowler Bowers range of mechanical two and three point bore micrometers are now available as XT extended travel holemikes, allowing a wide measurement range without the need to interchange anvils.



52-255-316-0

Features:

- 3-pt contact with tungsten carbide measuring anvils above 0.5"
- Blind bore measuring heads featured above 0.5"
- Ratchet stop for consistent measuring
- Extensions available for deep measuring
- Includes UKAS certificates for all Holemikes and setting rings



Order No.	Range	Grads.	Meas. Accuracy	Ring Depth	Ring Included	List Price	Sale Price
52-255-310-0	0.250" - 0.312"	0.00025"	0.00015"	2.28"	0.312"	\$745.30	\$596.24
52-255-311-0	0.312" - 0.375"	0.00025"	0.00015"	2.28"	0.312"	\$690.10	\$552.08
52-255-312-0	0.375" - 0.500"	0.00025"	0.00015"	2.28"	0.5"	\$690.10	\$552.08
52-255-313-0	0.500" - 0.625"	0.00025"	0.00015"	2.44"	0.5"	\$690.10	\$552.08
52-255-314-0	0.625" - 0.750"	0.00025"	0.00015"	2.44"	0.75"	\$707.70	\$566.16
52-255-315-0	0.750" - 1"	0.00025"	0.00015"	2.60"	0.75"	\$777.20	\$621.76
52-255-316-0	1" - 1.375"	0.00025"	0.00015"	2.60"	1.375"	\$1,107.40	\$885.92
52-255-317-0	1.375" - 2"	0.00025"	0.00015"	3.15"	1.375"	\$1,133.80	\$907.04
52-255-318-0	2" - 2.625"	0.00025"	0.0002"	3.15"	2.625"	\$1,352.50	\$1,082.00
52-255-319-0	2.625" - 3.250"	0.00025"	0.0002"	3.15"	2.625"	\$1,364.60	\$1,091.68
52-255-320-0	3.250" - 4"	0.00025"	0.0002"	3.94"	3.25"	\$1,702.40	\$1,361.92
Sets							
52-255-565-0	0.250" - 0.375" 2 heads, 2 handles, 1 ring					\$1,654.90	\$1,323.92
52-255-665-0	0.375" - 0.750" 3 heads, 3 handles, 2 rings					\$1,884.50	\$1,507.60
52-255-775-0	0.750" - 2" 3 heads, 3 handles, 2 rings					\$2,961.00	\$2,368.80
52-255-885-0	2" - 4" 3 heads, 3 handles, 2 rings					\$4,014.10	\$3,211.28

Fowler Bowers MicroGage 2-Point Small Bore Gaging System

Replaces 100's of pin gages!



The Fowler Bowers MicroGage 2-point bore gaging system has been designed specifically for the measurement of small bores between 1.0 - 6.0 mm. The measuring heads are equipped with spherical, split-ball, hard-chromed contact points.

Features:

- System range : 0.040" - 0.250"/1 - 6mm
- Switchable resolution 0.0005", 0.00005"/0.01, 0.001, 0.0005mm
- Repeatability : 0.00005"/0.001mm
- Sets include setting rings
- UKAS-certificates as standard with all setting rings
- Depth stops available, call our technical department 1-800-788-2353



See it in ACTION!



Order No.	Description	List Price	Sale Price
54-551-010-0	0.037" - 0.096"/0.95 - 2.45mm	\$3,382.58	\$3,128.00
54-551-011-0	0.060" - 0.167"/1.5 - 4.25mm	\$3,310.52	\$3,145.00
54-551-012-0	0.089" - 0.250"/2.25 - 6.35mm	\$3,563.68	\$3,385.00
Connectivity Cables			
54-115-526-0	Proximity cable with USB connection	\$143.00	\$135.00
54-115-527-0	Proximity cable with serial connection	\$143.00	\$135.00

Internal & External Electronic Caliper Gages



54-554-611-0



54-554-711-0

Features:

- Accuracy: $\pm 0.0008''/\pm 0.02\text{mm}$
- Resolution: $0.0002''/0.005\text{mm}$
- Analog scale for reversal point indication
- Large, LCD display
- Preset capability
- Absolute/Incremental measurements
- High-impact, aircraft aluminum case
- Rugged housing

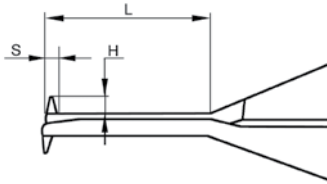

Dimensions for Internal Calipers

Metric	Inch	L	S	H	Tip Radius
5-15mm	0.2-0.6"	20mm	1.0mm	1.5mm	0.3mm
5-25mm	0.2-1.0"	35mm	1mm	1.5mm	0.3mm
10-30mm	0.4-1.2"	55mm	2mm	3.5mm	0.5mm
20-40mm	0.8-1.6"	80mm	3mm	6.5mm	0.5mm
30-50mm	1.2-2.0"	80mm	3mm	8.5mm	0.5mm

Dimensions for External Calipers

Metric	Inch	L	S	H	Tip Radius
0-10mm	0-0.4"	40mm	3mm	8mm	0.5mm
0-20mm	0-0.8"	80mm	6.5mm	25mm	0.75mm
10-30mm	0.4-1.2"	80mm	6.5mm	25mm	0.75mm
20-40mm	0.8-1.6"	80mm	6.5mm	25mm	0.75mm
30-50mm	1.2-2.0"	80mm	6.5mm	25mm	0.75mm

Order No.	Range	List Price	Sale Price
Internal Caliper Gages			
54-554-611-0	0.200" - 0.590"/5 - 15mm	\$213.18	\$180.00
54-554-622-0	0.200" - 1"/5 - 25mm	\$228.58	\$195.00
54-554-623-0	0.400" - 1.2"/10 - 30mm	\$239.25	\$205.00
54-554-624-0	0.790" - 1.6"/20 - 40mm	\$239.25	\$205.00
54-554-625-0	1.2" - 2"/30 - 50mm	\$239.25	\$205.00
External Caliper Gages			
54-554-711-0	0 - 0.400"/0 - 10mm	\$213.18	\$180.00
54-554-722-0	0 - 0.790"/0 - 20mm	\$228.58	\$195.00
54-554-723-0	0.4" - 1.2"/10 - 30mm	\$239.25	\$205.00
54-554-724-0	0.790" - 1.6"/20 - 40mm	\$239.25	\$205.00
54-554-725-0	1.2" - 2"/30 - 50mm	\$239.25	\$205.00

XTRA-VALUE Internal & External Electronic Caliper Gages



54-554-630-0



54-554-730-0

INCH • METRIC • FRACTION™

Features:

- Accuracy: 0.01"/0.3mm/1/64ths
- Reading: 0.01"/0.1mm/1/64ths
- Robust housing
- Large LCD display
- Spring loaded with locking nut

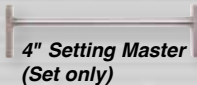

Order No.	Description	Range	List Price	Sale Price
54-554-630-0	Outside Caliper Gage	0 - 6"/0 - 150mm	\$58.19	\$47.00
54-554-730-0	Inside Caliper Gage	0.5" - 6"/12.7 - 150mm	\$58.19	\$47.00
54-554-650-0	Inside/Outside Caliper Gage Set includes 4" internal setting master		\$104.12	\$84.00

Prices & Specifications are subject to change without notice.



Dial Bore Gage Sets

Features:

- Carbide Anvils
- Easy-to-read
- Great value
- Graduation: 0.0005" or 0.01mm
- Insulated grip
- 9.5" depth
- Chrome plated handle
- Includes fitted case



52-646-100-0



52-646-300-0



XTENDER



52-646-400-0



Order No.	Range	Graduation	List Price	Sale Price
52-646-100-0	0.7" - 1.5"	0.0005"	\$174.02	\$142.40
52-646-300-0	2" - 6"	0.0005"	\$143.88	\$117.80
52-646-400-0	1.4" - 6"	0.0005"	<i>Compare to Mitutoyo 511-753 @ \$338.25</i>	\$179.00
52-646-500-0	1.4" - 6"	0.0001"	\$283.90	\$262.70
52-646-220-0	35 - 60mm	0.01mm	\$249.03	\$230.40

XTRA-RANGE[®] 4" to 12" Dial Bore Gage

Features:

- Carbide Anvils
- 10" measuring depth
- Easy-to-read
- Great value
- Graduation: 0.0005"
- Insulated grip
- Chrome plated handle
- Includes 2 contact extensions



Order No. 52-646-600-0

Sale \$240.⁰⁰

List \$267.18

2" to 6" Right Angle Dial Bore Gage

For measuring difficult-to-reach bores in tight or inconveniently located spaces on machine applications.

Features:

- Carbide anvils
- Easy-to-read
- Great value
- Graduation: 0.0005"
- Insulated grip



Order No. 52-646-250-0

Sale \$299.⁰⁰

List \$333.74

Bore Gage Setting Master Kits - Inch & Metric

Fowler's Bore Gage Setting Master Kit is used for accurately setting any bore gage up to 6"/150mm in diameter to an accuracy of 0.0001"/0.003mm

Each Set includes: Setting Device

- Base anvil: 3.950" x 1.050"
- Adjustable anvil 2.375" x .375" (two each)
- Internal capacity: 6"/150mm
- Centralizer capacity width: 2.750"
- Quick-release holder for fast adjustment

Economy Gage Block Sets

- Inch model:*
- 36 piece
 - Tolerances to .00005"
 - Certificate of Calibration to NIST

Metric model:

- 33 piece
- AS-2 grade
- Certificate of Calibration to NIST

**SCAN For
More Info**



**Includes:
Bore gage setting master and gage block set!
All in a custom-fitted case!**

Bore gage shown not included

Order No.	Description	List Price	Sale Price
53-646-000-1	Inch Bore Gage Setting Master Kit	\$411.69	\$315.00
53-646-010-0	Metric Bore Gage Setting Master Kit	\$365.53	\$292.42
53-646-005-0	Bore Gage Setting Master Kit - <i>without</i> Gage Blocks	\$254.47	\$180.00

IP67 **PLUS+** **Electronic Calipers**

with Smart Wireless Communication



54-100-556-BT

Features:

- HID Interface allows connection to most smart phones and tablets
- Wireless connectivity for quick error free data collection
- IP67 protected against fluid and dust
- Includes an extra battery tray and a 1" setting standard
- Supplied with NIST certification
- Heavy duty frame with 4-way measuring, inside, outside, depth and step
- Super large display
- Includes fitted case

Order No.	Range	Accuracy	List Price	Sale Price
54-100-554-BT	0 - 4"/100mm	0.001"/0.02mm	<i>Compare to Mitutoyo 500-762-20 @ \$237.59</i>	\$145.50
54-100-556-BT	0 - 6"/150mm	0.001"/0.02mm	\$205.59	\$149.60
54-100-558-BT	0 - 8"/200mm	0.0015"/0.04mm	\$250.03	\$195.00
54-100-512-BT	0 - 12"/300mm	0.0015"/0.04mm	\$266.64	\$215.00

EURO-CAL IV [®] **Electronic Calipers**

INCH • METRIC • FRACTION TM

54-100-330-1

Features:

- IP54 protected against fluid and dust
- Absolute/Incremental Measurement
- Resolution: 0.0005"/0.01mm (*Fractions in 1/64" increments*)
- Stainless steel frame
- 4-way measuring, inside, outside, depth and step
- Includes fitted case

Order No.	Range	Accuracy	List Price	Sale Price
54-100-330-1	6"/150mm	± 0.001"/0.02mm	\$146.96	\$120.00
54-100-331-0	8"/200mm	± 0.001"/0.02mm	\$173.91	\$126.50

Water Resistant IP54 Electronic Calipers

Absolute Reading!



54-100-777-2

Features:

- IP54 protected against fluid and dust
- Absolute/Incremental Measurement
- Resolution: 0.0005"/0.01mm
- 4-way measuring, inside, outside, depth and step
- Stainless steel frame
- Wireless SPC data option
- Includes fitted case



Order No.	Range	Accuracy	List Price	Sale Price
54-100-777-2	0 - 6"/150mm	0.0015"/0.04mm	\$161.70	\$132.30
54-100-712-2	0 - 12"/300mm	0.0015"/0.04mm	\$235.18	\$171.10
Accessory				
54-115-100-0	Wireless Transmitter		\$123.09	\$100.00
54-520-399-0	SPC cable (USB)		\$211.98	\$137.60

Digital Calipers

Absolute Reading!



54-100-000-2

Features:

- Resolution: 0.0005"/0.01mm
- Absolute/Incremental Measurement
- Stainless steel frame
- Direct Inch/Metric conversion
- 4-way measuring, inside, outside, depth and step
- Wireless SPC data option
- Includes fitted case

Order No.	Range	Accuracy	List Price	Sale Price
54-100-004-2	0 - 4"/0000mm	0.0015"/0.04mm	\$127.35	\$110.00
54-100-000-2	0 - 6"/150mm	0.001"/0.02mm	<i>Compare to Mitutoyo 500-196-30 @ \$141.40</i>	\$117.90
54-100-008-2	0 - 8"/200mm	0.0015"/0.04mm	\$169.07	\$138.40
54-100-112-2	0 - 12"/300mm	0.0015"/0.04mm	\$220.44	\$180.40
Accessories				
54-115-100-0	Wireless transmitter		\$123.09	\$100.00
54-520-399-0	SPC cable (USB)		\$211.98	\$137.60



XTRA-VALUE *Plus* Electronic Calipers



Features:

- IP54 protected against fluid and dust making it *great for shop environments*
- Range: 6"/150mm
- Accuracy: $\pm 0.001"/0.02\text{mm}$
- Resolution: $0.0005"/0.01\text{mm}$
- Inch/Metric/Fraction reading: $0.0005"/0.01\text{mm}/ 1/128"$
- Heavy Duty frame for extra rigidity and wear resistance
- Super large, easy to read 14 x 52mm display
- Combined thumbrest and thumbroll for fine adjustment
- Includes fitted case

Order No. 54-103-006-0

Sale \$80.⁰⁰

List \$88.00

XTRA-VALUE CAL Electronic Calipers



While supplies last!

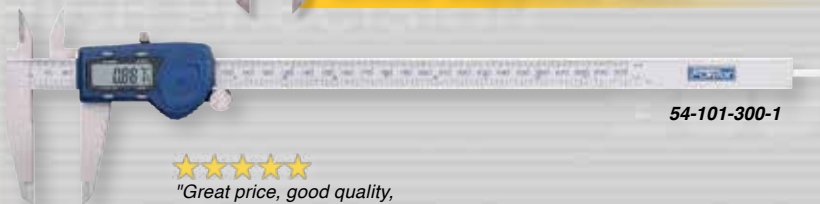

"Great price, good quality,
prompt processing"

Terri F.

Features:

- Accuracy: $0.001"/0.02\text{mm}$ (6" models)
- Stainless steel frame
- Large easy-to-read display
- Resolution: $0.0005"/0.01\text{mm}$
- Absolute/Incremental Measurement
- 4-way measuring, inside, outside, depth and step
- Includes fitted case



Order No.	Range	Display Type	List Price	Sale Price
54-100-888-0	6"/150mm	Regular Display - <i>Special Tool-A-Thon 21.2 pricing</i>		\$29.99
54-101-800-1	8"/200mm	Super Large Display with hold feature	\$110.22	\$90.20
54-101-300-1	12"/300mm	Regular Display - <i>includes FREE NIST Cert.</i>	\$112.64	\$92.20
54-101-900-1	12"/300mm	Super Large Display with hold feature	\$147.18	\$120.50

Premium Dial Caliper



Features:

- 4-way measuring, inside, outside, depth and step
- Solid stainless steel construction
- Silky smooth movement throughout
- 0 - 6" range, 0.100" per revolution, 0.001" graduations
- Thumbroll for rapid setting
- Knurled lock assures precise settings

Order No. 52-008-006-2

Sale \$127.00

List \$168.52

Machinist Grade Dial Calipers



52-008-707-0



"Very precise with consistent readings. I would never change this analog for a digital one"
Erick T.



Features:

- 4-way measuring, inside, outside, depth and step
- Solid stainless steel construction
- 0.100"/2mm range per revolution
- 0.001"/0.02mm reading dial face
- Tough shockproof gearing
- Includes fitted case

Order No.	Range	Dial Color	Accuracy	List Price	Sale Price
52-008-704-0	0 - 4"	White	± 0.001"	\$69.63	\$64.50
52-008-707-0	0 - 6"	Black	± 0.001"	\$95.00	\$83.00
52-008-708-0	0 - 8"	White	± 0.001"	\$114.08	\$99.00
52-008-712-0	0 - 12"	White	± 0.002"	Compare to Mitutoyo 505-746 @ \$230.00	\$119.90
52-008-709-0	0 - 150mm	Yellow	± 0.02mm	\$97.94	\$90.60

0 - 6" Dial Calipers



52-008-005-0



52-008-007-0

Features:

- 4-way measuring, inside, outside, depth and step
- Covered rack
- Accuracy ± 0.001"
- 0.100" per revolution
- Dial graduation: 0.001"
- Hardened stainless steel rack
- Includes fitted case

Order No.	Range	Dial Color	Accuracy	List Price	Sale Price
52-008-005-0	0 - 6"/150mm	Black	± 0.001"	\$103.73	\$78.90
52-008-007-0	0 - 6"/150mm	White	± 0.001"	\$103.73	\$78.90

Prices & Specifications are subject to change without notice.

XTRA-RANGE[®] Electronic Calipers



54-100-312-0

Features:

- IP54 protected against fluid and dust
- Resolution: 0.0005"/0.01mm
- Hold feature
- Absolute/Incremental measurement
- Preset mode includes offset size for ID measurements
- All sizes feature fine adjustment screw
- Includes shop hardened case



Order No.	Range	Accuracy	Jaw Depth	List Price	Sale Price
54-100-312-0	12"/300mm	± 0.002"	3.5"	\$259.55	\$240.10
54-100-024-1	24"/600mm	± 0.003"	4"	<i>Compare to Mitutoyo 550-225-10 @ \$1,031.00</i>	\$353.20
54-100-042-1	40"/1000mm	± 0.004"	4.9"		

Extended Range Dial Calipers

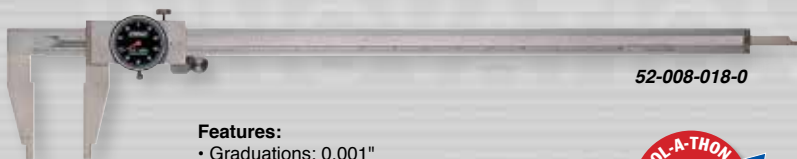

52-008-018-0

Features:

- Graduations: 0.001"
- Stainless steel construction
- Satin chrome finish
- Full length depth rod
- 0.50" internal measuring nibs on jaws



Order No.	Range	Accuracy	Jaw Depth	List Price	Sale Price
52-008-018-0	18"	± 0.003"	3.125"	\$300.40	\$277.90
52-008-024-0	24"	± 0.003"	3.375"	\$364.02	\$336.80

Heavy Duty Dial Calipers *with Cross Jaws*

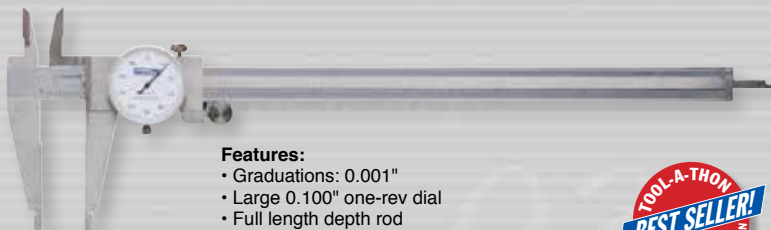

Features:

- Graduations: 0.001"
- Large 0.100" one-rev dial
- Full length depth rod
- 4-way measurement
- Cross-jaws for direct internal measurement
- Stainless steel, satin chrome finish
- 0.40" internal measuring nibs on bottom jaws



Order No.	Range	Accuracy	Jaw Depth	List Price	Sale Price
52-025-108-0	0 - 8"	± 0.0015"	2.5"	\$173.51	\$160.50
52-025-112-0	0 - 12"	± 0.002"	2.875"	\$240.53	\$222.50

X-TEST[®] Horizontal Indicators

NOW available with High Contrast Dial Face!

Features:

- Solid brass anti-magnetic housing
- Super smooth jeweled movement
- Smooth bezel adjustment for easy zero setting
- 0.080" and 0.120" carbide ball contact points (0.040" steel ball)
- 0.060" range with auto reverse and rev. counter
- Easy to read tilted dial
- 5/32" pivotable stem



52-562-002-BD

Includes NIST Certificate of Calibration

Order No.	Graduation	Dial Size	Dial Reading	List Price	Sale Price
52-562-001-BD	0.0005"	1-1/2"	0 - 15 - 0	Compare to Brown & Sharpe 74.111370 @ \$236.00	\$120.40
52-562-002-BD	0.0005"	1"	0 - 15 - 0	\$147.07	\$120.40

XTEST Horizontal Indicators

Features:

- Solid brass anti-magnetic housing
- Super smooth jeweled movement
- Smooth bezel adjustment for easy zero setting
- 0.080" and 0.120" carbide ball contact points (0.040" steel ball)
- 0.060" range with auto reverse and rev. counter
- Easy to read tilted dial
- 5/32" pivotable stem



52-562-001-0



52-562-002-0

Includes NIST Certificate of Calibration

Order No.	Graduations	Dial Diameter	Dial Reading	List Price	Sale Price
52-562-001-0	0.0005"	1-1/2"	0-15-0	Compare to Brown & Sharpe 74.111370 @ \$236.00	\$120.40
52-562-002-0	0.0005"	1"	0-15-0	Compare to Brown & Sharpe 74.111370 @ \$236.00	\$120.40
52-562-003-0	0.001"	1"	0-15-0	\$147.07	\$120.40
52-562-007-0	0.01mm	25mm	0-40-0	\$147.40	\$131.80
52-562-008-0	0.01mm	38mm	0-40-0	\$147.40	\$120.40

XTEST Vertical Indicators

TWICE the range of most indicators!

Features:

- Solid brass anti-magnetic housing
- Smooth bezel adjustment for easy zero setting
- 0.080" and 0.120" carbide ball contact points (0.040" steel ball)
- 0.060" range with auto reverse and rev. counter
- 5/32" pivotable stem



52-562-005-0



Includes NIST Certificate of Calibration

Order No.	Graduations	Dial Diameter	Dial Reading	List Price	Sale Price
52-562-004-0	0.0005"	1-1/2"	0-15-0	\$161.04	\$131.80
52-562-005-0	0.0005"	1"	0-15-0	\$161.04	\$131.80
52-562-006-0	0.001"	1"	0-15-0	\$161.04	\$131.80



Any Indicator on this page \$120.00

Test Indicators

All Fowler Test Indicators include bi-directional constant clockwise rotation, automatic reversal, three dovetail mountings, jeweled movement, two dovetail clamps and a molded case.

0.001"
0.0005"
Reading



Extra Points

.040" .120"

Order No.	Dial Color	Total Range	Dial Reading	Graduation	Dial Diameter	Point Length	List Price
52-562-774-0	white	0.030"	0-15-0	0.001"	1"	1/2"	\$138.27
52-562-778-0	black	0.030"	0-15-0	0.0005"	1"	1/2"	\$146.96
52-562-776-0	white	0.030"	0-15-0	0.0005"	1-1/2"	1/2"	\$153.67
52-562-780-0	black	0.030"	0-15-0	0.0005"	1-1/2"	1/2"	\$153.67

0.0001"
Reading



Extra Points

.040" .120"

Order No.	Dial Color	Total Range	Dial Reading	Graduation	Dial Diameter	Point Length	List Price
52-563-772-0	black	0.008"	0-4-0	0.0001"	1-1/2"	1/2"	\$146.96
52-563-777-0	white	0.008"	0-4-0	0.0001"	1-1/2"	1/2"	\$146.96

Extra
Long
Contact



Extra Points

.040" .120"

Order No.	Dial Color	Total Range	Dial Reading	Graduation	Dial Diameter	Point Length	List Price
52-562-782-0	black	0.020"	0-10-0	0.0005"	1"	1-7/16"	\$151.36
52-562-783-0	white	0.020"	0-10-0	0.0005"	1-1/2"	1-7/16"	\$151.36
52-562-784-0	black	0.020"	0-10-0	0.0005"	1-1/2"	1-7/16"	\$151.36

INDI-X^{blue} Electronic Indicators

21.2

Features:

- Accuracy: $\pm 0.001"/0.03\text{mm}$
- Resolution $0.0005"/0.01\text{mm}$
- 2-1/4" dial face
- Lugback and 3/8" stem mountings
- Tolerance function
- Absolute/incremental reading
- Floating zero



INCH • METRIC • FRACTION



54-520-255-0



★★★★★
"Easy to use, easy to read, top notch accuracy"

Mr. R



54-520-260-0

Order No.	Range	List Price	Sale Price
54-520-255-0	0.50"/12.5mm	Compare to Mitutoyo 543-783 @ \$170.00	\$91.70
54-520-250-0	1"/25mm	\$123.31	\$105.00
54-520-260-0	1"/25mm/64ths	\$125.18	\$102.50

INDI-X^{blue}

IP65 HIGH Resolution Electronic Indicator

Features:

- IP65 protected against fluid and dust making it *great for shop environments*
- Range: 1"/25mm
- Accuracy: $\pm 0.0002"/0.005\text{mm}$
- Resolution: $0.00005"/0.001\text{mm}$
- Carbide tip
- Tolerance function
- Contains flat and center lug backs
- Includes NIST certification and fitted case

Order No. 54-520-270-0

Sale \$135.⁰⁸

List \$168.85



INDI-X^{blue}

Small Face Electronic Indicator

Features:

- Range: 0 - 0.50"/0 - 12.5mm
- Accuracy: $\pm 0.0008"/0.02\text{mm}$
- Resolution: $0.0005"/0.01\text{mm}$
- 1.76" dial face
- Carbide tip
- Contains flat and center lug backs
- Includes NIST certification and fitted case

Order No. 54-520-275-0

Sale \$101.⁷³

List \$127.16



Indicators & Bases



Premium Dial Indicators

Features:

- AGD group 2
- Jeweled movement
- Tolerance markers
- Solid steel housing
- Carbide contact point



"Great price for a great indicator" V.C



52-520-105-0



52-520-110-2



52-520-120-0

Includes NIST Certificate of Calibration

52-520-110-1

Order No.	Range	Graduation	Reading	Balanced Reading	Dial Color	List Price	Sale Price
52-520-110-1	1"	0.001"	0 - 100	—	Black	Compare to Mitutoyo 2904S @ \$128.00	\$82.63
52-520-110-2	1"	0.001"	0 - 100	—	White	Compare to Mitutoyo 2904S @ \$128.00	\$82.63
52-520-135-0	0.05"	0.0001"	0 - 10	0 - 5 - 0	White	\$184.51	\$147.00
52-520-105-0	0.50"	0.001"	0 - 100	0 - 50 - 0	White	\$97.68	\$78.14
52-520-115-0	1"	0.001"	—	0 - 50 - 0	White	\$112.30	\$89.84
52-520-120-0	2"	0.001"	0 - 100	0 - 100	White	\$164.66	\$140.00
52-520-125-0	0.250"	0.0005"	0 - 50	0 - 25 - 0	White	\$136.29	\$109.03
52-520-129-0	1"	0.0005"	0 - 50	0 - 25 - 0	White	\$124.85	\$99.88
52-520-300-0	10mm	0.01mm	0 - 100	0 - 50 - 0	White	\$117.92	\$94.34
52-520-500-0	25mm	0.01mm	0 - 100	0 - 50 - 0	White	\$157.19	\$125.75

X-PROOFTM IP54 Shockproof Dial Indicators

Features:

- IP54 protected against fluid and dust
- Rubber bellows on stem
- O-ring seal on safety cap
- O-ring protection for bezel and rotating dial
- Sealed back plate
- Shockproof design
- Continuous reading: 0-100
- Tolerance markers
- AGD Group 2, 2-1/4" dia.
- Lugback and carbide point



52-520-450-0



52-520-455-0



Order No.	Range	Graduation	Reading	Contact Point	List Price	Sale Price
52-520-450-0	1"	0.001"	0 - 100	4 - 48 (3/8" stem)	\$89.59	\$85.20
52-520-455-0	1"	0.001"	0 - 100	4 - 48 (3/8" stem)	\$96.85	\$92.10



Dial Indicator

Features:

- Range: 1", dial dia. 2-1/4"
- AGD group 2
- Graduations: 0.001"
- Continuous reading: 0 - 100
- Supplied with lug backs positioned through 90° increments
- Carbide tipped contact points
- Microfine graduations in black for continuous readings and red for balanced readings



Order No. 52-520-110-0

Sale \$78.⁶⁰

List \$82.67

Indicator Extensions

Features:

- Made of stainless steel
- 7 popular sizes
- Stackable for extended lengths
- Available with either inch or metric threads
- Use to extend the contact point of dial indicators



Order No.	Description	List Price	Sale Price
Inch			
52-526-001-0	1", 4 - 48 thread	\$5.26	\$5.00
52-526-002-0	1-1/2", 4 - 48 thread	\$5.26	\$5.00
52-526-003-0	2", 4 - 48 thread	\$6.70	\$6.40
52-526-004-0	2-1/2", 4 - 48 thread	\$6.70	\$6.40
52-526-005-0	3", 4 - 48 thread	\$6.70	\$6.40
52-526-006-0	4", 4 - 48 thread	\$9.18	\$8.80
52-526-007-0	6", 4 - 48 thread	\$10.62	\$10.10
Metric			
52-526-011-0	1", M2.5 thread	\$7.85	\$7.50
52-526-012-0	1-1/2", M2.5 thread	\$8.41	\$8.00
52-526-013-0	2", M2.5 thread	\$8.41	\$8.00
52-526-014-0	2-1/2", M2.5 thread	\$8.41	\$8.00
52-526-015-0	3", M2.5 thread	\$8.41	\$8.00
52-526-016-0	4", M2.5 thread	\$9.99	\$9.50
52-526-017-0	6", M2.5 thread	\$12.84	\$12.20

Indicator Chucks



52-526-020-0

Features:

- Low carbon steel, black oxide finished
- 0.0140" - 0.040" chucking capacity
- Can be used with small pin gages for special or restricted applications
- Available in both 4 - 48 and M2.5 threads



Indicator shown
not included



Order No.	Description	List Price	Sale Price
52-526-020-0	Indicator Chuck with 4 - 48 thread	\$24.95	\$23.80
52-526-021-0	Indicator Chuck with M2.5 thread	\$24.95	\$23.80

Roto Dial Indicator Holder



52-585-400-0



52-585-411-0



52-585-415-0

Features:

- Made in the USA
- Rotates a full 360°
- Infinite adjustments
- Use with a mag base or alone in your machine
- 1", 0.001 graduation indicator
- Fine adjust magnetic base with 85 lb. pull (optional)
- Made from anodized 6061 billet aluminum

Order No.	Description	List Price	Sale Price
52-585-400-0	Roto Dial ONLY	\$178.00	\$169.10
52-585-411-0	Roto Dial with Premium Indicator	\$215.00	\$204.25
52-585-415-0	Roto Dial with Premium Indicator and Fine Adjust Mag Base	\$295.00	\$280.25

Depth Base Attachments



52-125-004-0

Features:

- Turn your dial or electronic indicator into a depth gage
- 4" length for accuracy
- Fits indicators with 3/8" and 8mm mounting stems ground and lapped base
- Each supplied with 4 extension points, for added application range (4 - 48 thread)
- 52-125-005-0 has 0.430" radius

Order No.	Description	List Price	Sale Price
52-125-004-0	Flat depth base attachment	\$45.43	\$37.20
52-125-005-0	Radius style depth base attachment	\$45.43	\$37.20

Height Transfer and Squareness Gage

A perfect match for **QuadraTest™** Indicators!

Features:

- Used for a variety of surface plate applications
- Large fine adjustment knob for precise control
- Swivel clamp anchors swivel and indicator for added accuracy
- Rear surface of the gage has a reference surface to place against a master for checking squareness
- Includes a 7.5" post, indicator rod and clamp

Indicator and standard shown not included



Order No. 53-620-010-0

Sale \$200.00

List \$374.88

High Precision Dial Gage Stand

Features:

- Quick positioning and adjustment
- Features fine adjustment of 5/32"
- Total height of column 14"
- Can hold indicators with stems of 3/8" and 8mm
- Supplied with two 2-3/8" diameter anvils, flat and serrated

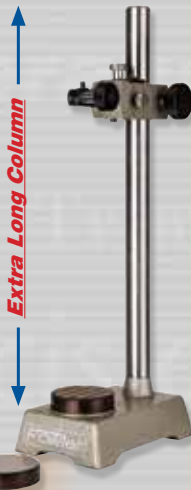

Order No. 52-580-014-0

Sale \$186.90

List \$196.70

Flex Arm Magnetic Base

Features:

- All purpose magnetic base with 180 lbs. of pulling power
- Base can be mounted vertically as well as horizontally
- V-bottom base allows mounting on cylindrical surfaces
- Adjusts to virtually any position



Order No. 52-585-015-0

Sale \$72.95

List \$91.19

XTRA-HEIGHT PLUS+

Electronic Height Gage

Measures ID/OD, centerlines, heights, widths, depths, min/max/delta, slots, grooves and more!

NEW

PERFECT for the Work Shop!

Features:

- Easy-to-use
- Range: 16"/407mm
- Repeatability: 0.00012"/0.003mm
- Resolution: 0.00005"/0.001mm
- Single probe holder
- Fixed measuring force 7.5N
- High contrast display
- Includes standard 4mm Ø ruby tipped probe, setting gage, AC adapter
- Accessory probes available



FREE Right Angle Depth Probe!

Order No. 54-190-002-0

Sale \$3,999.00

List \$4,150.00



Twin Beam Electronic Height Gages

with Offset Scriber

Features:

- Carriage design with offset scriber holder
- Base is ground and lapped for flatness
- Handwheel provides course and fine movement
- Updated electronic and mechanical design offers better accuracy and movement of carriage
- Carbide tipped scriber
- Functions include preset, in/mm conversion and ABS/INC for direct or comparative measuring



54-174-224-3

Range	Accuracy
12"	± 0.0016"/0.04mm
24"	± 0.002"/0.05mm

Twin Beam Dial Height Gages

- Separate digit counters register both upward & downward travel
- Zero setting can be obtained throughout the gage's range
- Coarse readings in 0.100" graduations; fine readings taken on indicator are 0.001"
- Dual chrome plated beams
- Carbide-tipped scriber.
- Base is hardened, ground & lapped for maximum flatness



52-174-212-0

Range	Accuracy
12"	± 0.0015"
24"	± 0.002"

Order No.	Range	List Price	Sale Price
54-174-212-3	12"/300mm	\$549.12	\$439.30
54-174-224-3	24"/600mm	\$768.68	\$629.00
Accessory			
54-174-226-0	Contact sensor	\$31.50	\$27.50

Order No.	Range	List Price	Sale Price
52-174-212-0	12"	\$329.45	\$269.60
52-174-224-0	24"	Compare to Mitutoyo 192-152 @ \$1,415.00	\$449.30

XTRA-MAG Height Electronic Height Gage

PLUS+

Features:

- **NEW** smaller sized, lightweight, aluminum base with embedded magnets allows positioning on machine tools, small fixtures, lathe beds where vibration can be an issue. Even mount it horizontally for unique applications.
- Range: 0 - 6" / 0 - 150mm
- Accuracy: 0.001"/0.01mm
- Resolution: 0.0005"/0.01mm
- Large, high contrast LCD display
- Direct Inch/Metric conversion
- ABS/INC measurement
- Floating zero
- Hold feature
- Positive carriage lock and fine adjust
- Carbide tipped scriber for measuring and scribing

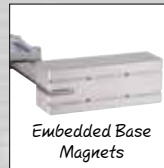

Order No. 54-176-006-0

Sale \$199.00

List \$216.70

Prices & Specifications are subject to change without notice.

Digi Level PLUS+

Features:

- IP65 protected against fluid and dust
- Large auto inverting display
- Includes a 6" straight edge with beveled edge and 1/32nds graduations
- Smart wireless available to connect to phone or tablet
- V's on top and bottom for measuring on cylindrical surfaces
- Embedded magnets on bottom base for vertical and horizontal hold
- Accuracy: $\pm 0.2^\circ$
- Resolution: 0.050°
- Rechargeable battery
- USB charging cable supplied

Vertical Positioning



Horizontal Positioning



54-422-550-0



Order No.	Description	List Price	Sale Price
54-422-550-0	Digi-Level PLUS	\$139.48	\$120.00
54-422-550-BT	Digi-Level PLUS with smart wireless	\$157.63	\$145.00

mini-MAG II

The mini-MAG II Protractor provides instant 360° digital inclination display of any angle.



Features:

- On/off, tilt %, light, zero functions
- Display is backlit for low light areas
- Embedded magnets with 3.5lb. pull
- Display automatically inverts
- Measuring range: 360° (4 x 90°)
- Accuracy: $\pm 0.2^\circ$
- Resolution: 0.05°
- Dimensions: 2.375" x 1.375" x 2.375"
- Hold feature

Order No. 54-422-460-0

Sale \$100.00

List \$123.53

mini-MAG PLUS

The Mini-Mag PLUS Protractor features a USB rechargeable battery, a backlit display, Tilt% function.



Features:

- IP54 protected against fluid and dust
- Auto off after 5 minutes
- Embedded magnets
- Display automatically inverts
- Smaller size: 2.12" x 2.12" x .9"
- Measuring range: 360° (4 x 90)
- Accuracy: $\pm 0.2^\circ$
- Resolution: 0.05°
- Hold feature
- Zero function

Order No. 54-422-500-0

Sale \$106.00

List \$129.91



Combination Squares



52-370-012-0

Features:

- Blades are chrome plated, fully hardened and tempered
- 4 piece includes: square, protractor and center heads with 12" blade
- 2 piece includes: square head and 12" blade
- Square head has level and scriber point
- Double indexed protractor is graduated 180° in both directions
- Graduated in 8ths, 16ths, 32nds and 64ths

Order No.	Description	List Price	Sale Price
52-370-012-0	4 piece combination square	\$236.50	\$189.20
52-373-012-0	2 piece combination square	\$152.21	\$121.77

QUICK CHECK

Multi-Function Check Standard



Check

- ✓ Height Gages
- ✓ Micrometers
- ✓ Depth Gages
- ✓ Bore Gages
- ✓ Test & Dial Indicators
- ✓ Caliper Gages
- ✓ Protractors & more ...



Features:

- All sizes marked are actual
- Accuracy of indicated values $\pm 0.00012''$
- One compact, multi-function, precise standard
- Can be used to check and verify a multitude of measuring instruments
- Supplied with a manufacturer's test certificate and fitted wood case

Order No. 53-813-015-0

Sale \$1,550.00

List \$1,877.01

SHOP-BLOX®

Rectangular Gage Block Sets



53-672-081-0



"Perfect for small shops. A really great bang for the buck"

M.L.L

Features:

- Manufactured to meet Federal Specification ASME B89. 1.9 - 2002 tolerances on length for inch gage blocks
- Certificate of Calibration traceable to NIST
- Tolerances to $\pm 0.00005''$
- In high-quality fitted wood case

Order No.	Description	List Price	Sale Price
53-672-036-0	36 piece Rectangular Gage Block Set	\$368.44	\$310.00
53-672-081-0	81 piece Rectangular Gage Block Set	\$630.18	\$535.00

Prices & Specifications are subject to change without notice.

SPACE X-BLOX[®] PLUS+ Sets

Pre-sized, solid aluminum.
Common sizes used for
setting heights, drill press
depth stops and fences.



SCAN For
More Info



Available in two combination sets!

Features:

- Accuracy: 0.001" on all sides
- All blocks are 3" long by 1/2" high
- 1-2-3 blocks feature 1/32" graduations on 2" and 3" sides
- Blue anodized finish
- Includes fitted case

Included with sets!



6" Straight Edge PLUS

Useful for layout and alignment applications!

Order No.	Description	List Price	Sale Price
52-439-050-0	Block sizes in matched pairs: 1-2-3 blocks, 3/4", 1/2", 3/8", 1/4", 3/16", 1/8", 1/16"	\$195.00	\$180.00
52-439-055-0	Block sizes (1 each): 1-2-3- block, 3/4", 23/32", 1/2", 15/32", 7/16", 3/8", 5/16", 1/4", 7/32", 3/16", 5/32", 1/8", 3/32", 1/16"	\$195.00	\$180.00



XTRA-TRI[®] PLUS+ Square Set

Perfect for set up and layout work, measuring and marking angles.
Used for metal working, wood working and fabrication



SCAN For
More Info



Features:

- 4" and 7" squares with embedded magnets for horizontal and vertical position holding
- Carbide tipped scribe

Included with sets!



6" Straight Edge PLUS

Useful for layout and alignment applications!

Order No. 52-432-100-0

Sale \$185.00

List \$199.95

1-2-3, 2-3-4 & 2-4-6 Blocks



52-439-234-0

Features:

- 23 holes for easy clamping
- Sold in pairs
- Hardened 56 - 60 HRC
- Useful in layout and grinding work

Order No.	Description	Accuracy	List Price	Sale Price
52-439-031-0	1-2-3 Blocks	± 0.0002"/1"	\$105.82	\$84.66
52-439-234-0	2-3-4 Blocks	± 0.0001"/1"	\$110.00	\$92.00
52-439-246-0	2-4-6 Blocks	± 0.0003"/1"	\$249.59	\$199.67

Parallel Set

Features:

- 1/2", 5/8", 3/4", 7/8", 1", 1-1/8", 1-1/4", 1-3/8", 1-1/2" & 1-5/8" heights, 6" lengths
- Height specifications relate to consistency within each pair. Absolute heights are nominal
- Hardness: 50 HRC, 6" length and 1/32" thickness
- Parallelism: $\pm 0.0002"$
- Paired Height: $\pm 0.001"$



Order No. 52-437-000-0

Sale \$257.⁶⁰

List \$278.40

Cylindrical Squares

Features:

- Used for checking squares, height gages and other instruments
- Hardened and the ends are lapped to 90° angular accuracy
- 6" cylindrical squares: $\pm 0.0001"$
- 12" cylindrical square: $\pm 0.00015"$



52-750-006-0



52-750-012-0

Order No.	Description	List Price	Sale Price
52-750-006-0	6"	\$230.21	\$218.70
52-750-012-0	12"	\$328.75	\$312.40

Super Heavy Duty Automatic Center Punch



Features:

- The pressure of marking is controlled by rotating the knurled cap. Screw the cap down for heavy indentations and screw the cap upward for lighter markings.
- Steel construction. Four knurled bands provide a sturdy grip
- The point is easily removed for sharpening

Order No. 52-500-290-0

Sale \$22.³⁰

List \$23.42

Carbide Super Scriber



- Lightweight
- Retractable carbide tip
- Knurled grip
- Machined aluminum body
- Pocket clip

Order No.	Description	Overall Length	List Price	Sale Price
52-500-050-0	Carbide Super Scriber	6.5"	\$38.01	\$36.20
52-500-055-0	Carbide Refill		\$11.44	\$10.90

Electronic Edge Finders

Features:

- Six equally spaced light ports provide visibility at any angle
- Edge finder lights instantly when stylus touches work edge
- Repeatability: 0.0002"
- Works on any conductive metal



54-575-600-0



54-575-625-0



54-575-650-0

Along with light indication, model #54-575-650-0 emits an audible "beep" at time of contact

Order No.	Stylus	Shank	Audible	List Price	Sale Price
54-575-600-0	0.200"	1/2"	NO	\$42.00	\$37.80
54-575-625-0	0.200"	1/2"	NO	\$145.00	\$130.50
54-575-650-0	0.400"	3/4"	YES	\$145.00	\$130.50

Prices & Specifications are subject to change without notice.

Z-CHECK 65 PLUS+

Z-Axis Tool Setter

Features:

- Supplied with zero reference setting block
- IP65 protected against fluid and dust
- Back light turns on when zero reference is achieved
- 4 magnets embedded into base
- 2" default setting height
- Steel contact surface with 0.0002" flatness
- Resolution: 0.00005"/0.001mm
- Repeatability: 0.00015"/0.004mm
- Accuracy: 0.0001"/0.003mm
- Includes a rugged, aluminum fitted case



Display lights when ZERO reference is reached.



Order No. 54-188-200-0

Sale \$122.¹⁰

List \$128.48

HIGH Accuracy Z-Axis Detectors



For use in CNC machines and other applications where high accuracy is required!



54-188-140-0



Micro Drill Application



Features:

- IP67 protected against fluid and dust
- High accuracy and repeatability, $\pm 0.000039"/0.001\text{mm}$
- Carbide touch surface (0.196"/5mm)
- High precision bearing guide system for long life
- Interchangeable magnetic base
- High visibility LED indicator
- Movement stroke 0.078"/2mm
- Battery life approximately 250 hours (on time)

54-188-140-0

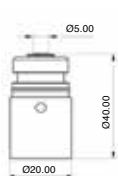

54-188-150-0

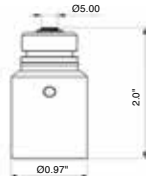

Order No.	Model	Dimensions	List Price	Red Price
54-188-150-0	Inch	Height: 2"/50.8mm, Dia. 0.97"/24.638mm	\$275.98	\$262.20
54-188-140-0	Metric	Height: 1.57"/40mm, Dia. 0.78"/20mm	\$275.98	\$262.20

Tool Set 300 Presetter

Used for the quick checking of heights and diameters (radii) of various types of machine tools. Accuracy is guaranteed by a precise steel measuring column and displacement devices in X and Z coordinates utilizing constant measuring force.



Tool Holding Spindle

Tool presetter is supplied with high precision tool pot (Grade 0)

High precision spindle has:

- ISO 50 taper
- Less than 2 μ m concentricity error



Features:

- Measuring range: (X)11.8"/300mm, (Z)15.7"/400mm
- Min/Max functions for TIR readings
- 2 reference indications
- Preset and Tolerance value inputs
- Radius or diameter indication on X-axis display
- Measuring unit (mm/inch) indication
- Display hold to retain readings
- Output - OPTO RS232 for each axis
- Floating zero function anywhere within axis range
- Carbide measuring insert for durability
- Counter balanced measuring carriage
- Constant measuring force in both axes
- **High precision Swiss measuring system**

Order No.	Description	List Price	Sale Price
54-188-300-0	Tool Presetter	\$11,096.59	\$9,350.00
54-121-000-0	ISO 50/45 Tool Pot Adapter	\$1,196.43	
54-121-005-0	ISO 50/40 Tool Pot Adapter	\$772.40	
54-121-010-0	ISO 50/35 Tool Pot Adapter	\$1,196.43	
54-121-015-0	ISO 50/30 Tool Pot Adapter	\$963.26	
54-188-333-0	ISO 50 Setting Gage	\$640.00	
54-188-335-0	ISO 40 Setting Gage	\$1,136.10	

COAX-2D 2 Dimensional Coaxial Indicator Sets

Use the 2D Coaxial Set for accurate component centering and positioning in most machining applications. The dial remains stationary during the rotation of the machine spindle.

Features:

- Graduations and revolution counter 0.0005"/0.01mm
- 3 internal and 3 external feelers; ball dia.: 1/8" (3mm)
- Includes center point feeler and staining arm
- Restraining arm
- Shank: 3/8" dia. x 7/8" long (10mm x 20mm)
- Measuring range: 0.250" (6mm) axis offset
- Speed recommended 800 RPM max.
- Repeatability to within 0.0002" (0.005mm) of true center
- Capacity, depending on feeler is 5/32-12"/4-300mm) internal diameter; 0-12"/0-300mm external diameter



52-710-025-0

Order No.	Description	List Price	Sale Price
52-710-025-0	2D Coaxial Set - Inch	\$281.82	\$230.60
52-710-030-0	2D Coaxial Set - Metric	\$287.32	\$235.00

Prices & Specifications are subject to change without notice.

X-PRO™

Portable Roughness Tester II



54-410-500-0

Features:

- Small, compact size
- 2 selectable parameters: Ra and Rz
- Large LCD display
- Meets ISO and DIN standards
- N.I.S.T. traceable specimen included
- Uses 9 volt battery (approx. 3000 measurements)
- Includes fitted case



The X-Pro Portable Roughness Tester II can be used for various applications by selecting from a variety of accessories including special application probes and a swivel stand.

RS232 data output is available on additional models (contact the Fowler technical department for more information 1-800-788-2353)



(X-Pro shown with optional stand with swivel)

X-Pro Portable Roughness Tester II

Order No.	Description	Sale Price
54-410-500-0	Portable Surface Roughness Tester 0.0004" probe (NIST specifications) <i>Compare to MAHR EMD-1500-311 @ \$2395.00</i>	\$1,666.70
54-410-600-0	Portable Surface Roughness Tester 0.0002" probe (DIN specifications) <i>Compare to MAHR EMD-1500-311 @ \$2395.00</i>	\$1,666.70

X-Pro Portable Roughness Tester II Stand with Swivel

Order No.	Description	List Price	Sale Price
54-400-896-0	Stand with Swivel Attachment	\$490.60	\$475.00

X-Pro Portable Roughness Tester II Probes and Accessories

Order No.	Description	Resolution	List Price	Sale Price
54-400-319-0	General Purpose Probe	0.0004"	\$800.00	\$720.00
54-400-326-0	General Purpose Probe	0.0002"	\$800.00	\$720.00
54-420-321-0	Small Bore Probe	0.0004"	\$885.72	\$778.50
54-420-327-0	Small Bore Probe	0.0002"	\$885.72	\$778.50
54-420-301-0	Traverse Chisel Probe	0.0004"	\$885.72	\$778.50
54-420-302-0	Parallel Chisel Probe	0.0004"	\$885.72	\$778.50
54-420-328-0	Groove Bottom Probe	0.0004"	\$885.72	\$778.50
54-420-120-0	AC Adapter Kit		\$75.02	\$61.40

Weight & Counting Scale



Measures up to 66 lbs.!



Features:

- Accurately measures weights and quantities
- Use for counting large batches of small parts
- Measure weights up to 66 lbs./30 kg.
- Removable stainless steel weighing pan and durable ABS housing
- Converts pounds, ounces, grams, kilograms
- Internal battery with 100 hours of use
- Front panel leveling indicator with adjustable leveling feet
- 3 panel backlit LCD display indicates weight, average piece weight and count

Order No. 54-750-030-0

Price \$170.00





HIGH PRECISION

MAKING MEASUREMENT EASY

Headquarters

66 Rowe Street • Newton • Massachusetts 02466
(800) 788-2353 • (617) 332-4137 fax
sales@fowlerprecision.com

Distribution Center & Showroom

28010 Industry Drive
Valencia, California 91355
(415) 633-5354

Find us on social media

